

IDEA StatiCa, s.r.o.

IDEA RCS

Reinforced cross-section design

Version 8

CONTENTS

1 Introduction	7
1.1 Program requirements	7
1.2 Installation guidelines	7
2 Terminology	8
2.1 Section	8
2.2 Loads extreme	9
2.3 Design member	9
2.4 Reinforced section	9
3 User interface	10
3.1 View controls in the main window	10
3.1.1 DXF export settings	11
3.2 Table editor	11
4 Creating new project	13
4.1 Project data and default values setting	15
5 Working with sections	17
5.1 Ribbon group Set	18
5.2 Ribbon group Import	18
5.3 Ribbon group Section	20
5.3.1 New section input	20
5.4 Ribbon group Extreme	21
5.4.1 Editing load extremes using table editor	21
5.5 Ribbon group Design member	22
5.5.1 New design member input	22
5.6 Ribbon group Reinforced cross-section	24
5.6.1 New reinforced cross-section	24
5.6.2 Copy of reinforced section	24
5.6.3 Copy of reinforcement	24
5.7 Ribbon group Calculation	26
5.8 Ribbon group Report	26
5.8.1 Global report setting	27
5.8.2 Detailed report setting	29
6 Design members	32
6.1 Design member data common to all members	33
6.2 Compression member data	34
6.3 Data for Flexural slenderness calculation	35
6.3.1 Ribbon group Design member	35
7 Reinforced cross-sections	36
7.1 Ribbon group Reinforced cross-section	36
8 Cross-section shape	37
8.1 Input of new cross-section	37
8.2 General cross-sections	38
8.3 Cross-section dimensions input	39
8.4 Input of general section by coordinates of vertices	40
8.4.1 Input of openings into general cross-section	41
8.4.2 New general opening	42
8.4.3 New rectangular opening	42
8.4.4 New circular opening	44
8.4.5 Shift origin of general cross-section	46
8.5 Dimension line of cross-section shape	46
8.6 Cross-sectional shape modifications	47
8.6.1 Composite cross-section modification	47
9 Prestressing reinforcement	49
9.1 Prestressing reinforcement editor	50

9.1.1 Tendons	51
9.1.2 Tendon ducts	56
9.1.3 Deleting prestressing reinforcement	61
9.1.4 Import and export of prestressing reinforcement	61
9.1.5 View settings of reinforced cross-section	61
9.2 Editing tendons	63
9.3 Editing tendon ducts and debonding tubes	64
9.4 Deleting prestressing reinforcement	65
9.5 View settings of reinforced cross-section	65
10 Construction and action stages	66
10.1 Construction stages	66
10.1.1 Ribbon group Time axis points	67
10.1.2 Ribbon group Time axis label	67
10.1.3 Ribbon group Cross-section	68
10.2 Action stages	69
10.2.1 Effect in cross-section components	70
10.2.2 Ribbon group Recalculation of losses	70
10.2.3 Ribbon group Resultant of stage	70
11 Load effects input	72
11.1 1D section internal forces	72
11.2 2D Section internal forces	74
11.2.1 Ribbon group Recalculation of design forces	75
11.3 Second order effects	76
11.3.1 Ribbon group Recalculation of internal forces	77
11.4 Load effects on staged sections	79
11.4.1 Taking load actions from action stages	80
11.4.2 Ribbon group Resultant of stage	80
12 Concrete reinforcement	81
12.1 Concrete reinforcement of 1D members	82
12.1.1 Editing cover of 1D sections	83
12.1.2 Input of 1D members reinforcement by template	84
12.1.3 Input of one-way slabs reinforcement by a template	86
12.1.4 Editing stirrups	87
12.1.5 Editing links	87
12.1.6 Longitudinal reinforcement editing	88
12.2 Editor of reinforcement of 1D members	91
12.2.1 Editing cover	92
12.2.2 Input of reinforcement by template	93
12.2.3 Input of one-way slabs reinforcement by a template	96
12.2.4 Reinforcement design	97
12.2.5 Shear reinforcement	98
12.2.6 Longitudinal reinforcement	107
12.2.7 User settings of reinforced cross-section	115
12.2.8 Deleting reinforcement	117
12.2.9 Import and export of reinforced cross-section	117
12.2.10 View settings of reinforced cross-section	117
12.3 2D members reinforcement	119
12.3.1 Input of 2D members reinforcement by a template	119
12.3.2 Input of new bars for 2D member cross-sections	120
12.3.3 Editing 2D members longitudinal reinforcement	122
12.3.4 Shear reinforcement of 2D members	123
12.4 User defined reinforcement templates	125
12.5 Deleting reinforcement	125
12.6 Import of reinforced cross-section	125
12.7 Export of reinforced cross-section	126
12.8 View settings of reinforced cross-section	126
13 Check results	127
13.1 Setting of check execution of 1D members	127

13.2 Setting of check execution of 2D members	129
13.3 Setting the evaluated combination	129
13.4 Calculation mode settings	130
13.5 Setting of the checked direction for 2D members section check	130
13.6 Overall check	131
13.6.1 Ribbon group Component labels	131
13.6.2 Ribbon group Calculation	132
13.7 Section Capacity check	133
13.7.1 Ribbon group Type of results	133
13.7.2 Ribbon group Combinations	134
13.7.3 Ribbon group Checked directions	134
13.7.4 Ribbon group Diagram type	134
13.7.5 Ribbon group Interaction surface sections	134
13.7.6 Ribbon group Draw points	134
13.7.7 Ribbon group Grid of interaction surface sections	135
13.7.8 Ribbon group Export of interaction diagram	135
13.7.9 Ribbon group Colors settings	135
13.7.10 Ribbon group Drawing settings	136
13.7.11 Ribbon group Calculation	136
13.7.12 Ribbon group Code and calculation settings	136
13.8 Shear check	137
13.8.1 Ribbon group Combinations	137
13.8.2 Ribbon group Code and calculation settings	137
13.8.3 Ribbon group Resistance area	137
13.8.4 Ribbon group Calculation	137
13.9 Torsion check	138
13.9.1 Ribbon group Combinations	138
13.9.2 Ribbon group Code and calculation settings	138
13.9.3 Ribbon group Calculation	138
13.10 Interaction check of shear, torsion, bending and normal force	139
13.10.1 Ribbon group Combinations	139
13.10.2 Ribbon group Code and calculation settings	139
13.10.3 Ribbon group View	139
13.10.4 Ribbon group View setting	139
13.10.5 Ribbon group Checked directions	139
13.10.6 Ribbon group Strain	140
13.10.7 Ribbon group Stress	140
13.10.8 Ribbon group Results label	140
13.10.9 Ribbon group Results graph	141
13.10.10 Ribbon group Resultant forces	141
13.10.11 Ribbon group Cross-section	142
13.10.12 Ribbon group Type of results	142
13.10.13 Ribbon group Calculation	143
13.10.14 Check by Stress-strain diagram	144
13.11 Fatigue check	146
13.11.1 Ribbon group View	146
13.11.2 Ribbon group View setting	146
13.11.3 Ribbon group Checked directions	146
13.11.4 Ribbon group Strain	146
13.11.5 Ribbon group Stress	146
13.11.6 Ribbon group Results label	146
13.11.7 Ribbon group Results graph	146
13.11.8 Ribbon group Resultant forces	146
13.11.9 Ribbon group Cross-section	146
13.11.10 Ribbon group Type of results	146
13.11.11 Ribbon group Fatigue combination	146
13.11.12 Ribbon group Calculation	147
13.12 Stress limitation check	148
13.12.1 Ribbon group View	148
13.12.2 Ribbon group View setting	148
13.12.3 Ribbon group Checked directions	148

13.12.4 Ribbon group Strain	148
13.12.5 Ribbon group Stress	148
13.12.6 Ribbon group Results label	148
13.12.7 Ribbon group Results graph	148
13.12.8 Ribbon group Results	148
13.12.9 Ribbon group Cross-section	148
13.12.10 Ribbon group Type of results	148
13.12.11 Ribbon group Export	148
13.12.12 Ribbon group Calculation	149
13.12.13 Ribbon group Code and calculation settings	149
13.13 Crack width check	150
13.13.1 Ribbon group View	150
13.13.2 Ribbon group Checked directions	150
13.13.3 Ribbon group View setting	150
13.13.4 Ribbon group Strain	150
13.13.5 Ribbon group Stress	150
13.13.6 Ribbon group Results label	150
13.13.7 Ribbon group Results graph	150
13.13.8 Ribbon group Results	150
13.13.9 Ribbon group Cross-section	150
13.13.10 Ribbon group Type of results	151
13.13.11 Ribbon group Export	151
13.13.12 Ribbon group Calculation	151
13.13.13 Ribbon group Code and calculation settings	151
13.13.14 Ribbon group Cracks	151
13.14 Flexural slenderness check	152
13.15 Brittle failure check	153
13.16 Detailing check	154
13.16.1 Ribbon group Components label	154
13.16.2 Ribbon group Calculation	154
13.17 Response check	155
13.17.1 Ribbon group Combinations	155
13.17.2 Ribbon group View	155
13.17.3 Ribbon group View setting	155
13.17.4 Ribbon group Checked directions	155
13.17.5 Ribbon group Strain	155
13.17.6 Ribbon group Stress	155
13.17.7 Ribbon group Results label	155
13.17.8 Ribbon group Results graph	155
13.17.9 Ribbon group Resultant forces	155
13.17.10 Ribbon group Cross-section	155
13.17.11 Ribbon group Type of results	155
13.17.12 Ribbon group Calculation	155
13.18 Stiffness calculation	156
13.18.1 Ribbon group View	156
13.18.2 Ribbon group View setting	156
13.18.3 Ribbon group Strain	156
13.18.4 Ribbon group Stress	156
13.18.5 Ribbon group Results label	156
13.18.6 Ribbon group Results graph	156
13.18.7 Ribbon group Results	156
13.18.8 Ribbon group Cross-section	156
13.18.9 Ribbon group Type of results	156
13.18.10 Ribbon group Calculation	156
13.18.11 Ribbon group Code and calculation settings	156
13.19 Calculation of M-N- κ diagram	157
13.19.1 Ribbon group View	157
13.19.2 Ribbon group M-N- κ	157
13.19.3 Ribbon group View setting	157
13.19.4 Ribbon group Strain	157
13.19.5 Ribbon group Stress	158

13.19.6 Ribbon group Results label	158
13.19.7 Ribbon group Results graph	158
13.19.8 Ribbon group Results	158
13.19.9 Ribbon group Cross-section	158
14 Materials database	159
15 Code and calculation settings	160
16 Application setting	162
16.1 Units setting	162
16.2 Application global settings	164
16.2.1 Results drawing settings	164
16.2.2 Reinforcement drawing settings	164
16.2.3 Cross-section drawing setting	165
16.2.4 Text height settings	165
16.2.5 Miscelanous settings	166
17 Format of text files for import and export	167
17.1 File TXT	167
17.2 File .NAV	168
17.3 Import from XML file	171
17.3.1 Cross-sections	172
17.3.2 Materials	178
17.3.3 Members 1D	179
17.3.4 Haunches	180
17.3.5 Arbitrary members	180
17.3.6 2D members	181
17.3.7 Load cases	181
17.3.8 Combinations	181
17.3.9 Named selections	181
17.3.10 General rules used when converting internal forces to loads extremes in IDEA RCS	181
17.3.11 Internal forces on members	183
17.3.12 Member 2D – internal forces	184

1 Introduction

1.1 Program requirements

Application requires .NET Framework 4.5 to be installed on the computer. It can be downloaded from web pages of Microsoft Company (<https://www.microsoft.com/en-US/download/details.aspx?id=30653>).

In case of a missing .NET Framework the installation is not launched.

1.2 Installation guidelines

IDEA RCS program is installed as a part of IDEA StatiCa package.

2 Terminology

IDEA RCS is a software for the calculation of reinforced concrete section checks according to EN 1992-1-1 and 1992-2 with or without a national application document and for the calculation of reinforced concrete section checks according to SIA 262:2003.

It is a standalone application used in addition to a standard static analysis.

IDEA RCS can be used in two modes:

- As a standalone application in addition to a standard static analysis. Cross-sections, reinforcement and load effects have to be entered by user.
- As a module linked to superior application. Cross-sections and load effects or prestressing reinforcement are generated from superior application. In this mode not all functionality may be available as in standalone application. Data for standalone IDEA RCS application can be exported from IDEA RCS running as a module.

Program can perform checks for:

- Concrete member sections with longitudinal, torsional and shear reinforcement for Ultimate limit state Design (ULS) and Serviceability Limit State Design (SLS) with an optional function to calculate the long or short term stiffness of (cracked) cross-section for deflection verification. Moreover, a detailed response check for user defined internal forces is available as well as a possibility to analyze the interaction of all internal forces including shear and torsional forces. A set of practical cross-section like T-, L-, Rectangular, Circular or O-shaped cross-section can be used as well as a free form cross-section (so called 'general cross-section')
- Concrete slab sections in a defined point for one-way, two-way slabs, walls or deep beams for Ultimate limit state Design (ULS) and Serviceability Limit State Design (SLS). Moreover, a detailing response check and check of the crack width is available.
- Prestressing can be applied into cross-sections of beams either using pre-tensioned tendons or using post-tensioned tendons.

2.1 Section

The application works with individual sections. The section is defined with relation to specific member data and reinforcement data (configurations).

One or more sets of loads effects (loads extremes) are assigned to each section.

One IDEA RCS project can contain multiple sections with multiple members, reinforcement configurations and load effects.

The application works for types of sections

- **1D member sections.** For a 1D member section only the member data and the load effects of 1D members can be specified. Cross-sections can be reinforced with reinforcement or tendons. Tendons are taken into account as reinforcement – effects of prestressing are not taken into account.
- **2D member sections.** For a 2D member section only the member data and load effects of 2D members can be specified.
- **1D staged member sections.** For a 1D staged member section data and staged load effects of 1D member can be specified. Cross-sections can be reinforced with reinforcement or tendons. Effects of prestressing in tendons are taken into account.

2.2 Loads extreme

Loads extreme is a set of combinations of internal forces, specifically one combination for Ultimate Limit States and three for Serviceability Limit States (Characteristic, Frequent, Quasi-permanent).

More loads extremes can be assigned to one section. When check of single section is performed, reinforced section is checked only for current loads extreme. When summary check of all sections is performed, each section is checked for all loads extremes assigned to section.

2.3 Design member

The design member data defines the information about the whole element (type, exposure class, creep coefficient, etc.) for which a specified section is being checked. User defined design member data can be assigned to multiple sections. Any change in the design member data is reflected in all related sections, which are assigned to the design member, for which data is edited.

2.4 Reinforced section

The reinforced section defines the information about reinforcement configuration: section geometry, longitudinal reinforcement, shear reinforcement, applied cover(s) and reinforcement materials. User defined Reinforced section configuration can be assigned to multiple sections. Any change in the Reinforced section data is reflected in all sections with the assigned Reinforced section data.

3 User interface

The items of user interface of the application are composed into following groups:

- **Navigator** – it contains main commands for the work with a project.
- **Ribbons** – there are sets of controls. Ribbons content changes according to the current Navigator command.
- **Main window** – it is used mainly for appropriate drawings.
- **Data window** – properties of objects and results of analysis are displayed in this window according to current Navigator command.
- **Information window** – actual overall information is shown.

All other IDEA applications have the similar design.

The screenshot displays the IDEA StatiCa RCS software interface. The main window shows a 2D view of a beam cross-section with dimensions and analysis results. The data window displays the following tables:

Response N-M-M

Results presented for combination : Fundamental ULS

$N_{ext, tot}$ [kN]	$M_{ext, y, tot}$ [kNm]	$M_{ext, z, tot}$ [kNm]	Concrete fibre	Extreme in bar	Extreme in tendon	Value [%]	Limit [%]	Check
-3048.7	3277.8	61.0	12	15	1	100.0	100.0	OK

Plane of strain

x_{add} [cm]	x [cm]	d [cm]	z [cm]	ϵ_x [1e-4]	ϕ_z [1e-4]	ϕ_y [1e-4]
18	26	136	128	23.3	-0.2	-65.2

Forces in components of cross-section

Component of css	N [kN]	M_y [kNm]	M_z [kNm]	A [cm ²]	y_i [cm]	z_i [cm]
Concrete	-4116.9	1861.7	66.0	2691	2	45
Reinforcement in tension	546.4	403.5	0.0	13	0	-74
Reinforcement in compression	-403.6	196.3	13.5	25	3	46
Tendons	3974.1	3548.6	-79.5	27	2	-89
Total	0.0	6000.0	0.0			

3.1 View controls in the main window

The view in 2D window can be set by mouse or by tool in the left upper corner of the window.

-  - zoom all. Click this button to fit the whole structure to the 2D window.

To set the required view using keyboard and mouse following combinations can be used:

- Click and hold mid mouse button – moving the mouse pans the view.
- Roll with mid mouse button – moving the mouse increases / decreases the view.
- Push CTRL+SHIFT and hold mid mouse button – moving the mouse defines the window for zoom.

Click right mouse button over 2D window shows context menu with following commands:

- **Zoom all** – zoom to show the whole current structure in the 2D window.
- **Print** – start printing of the current content of 2D window on selected printer.
- **To bitmap** – start export of the current content of 2D window to the raster graphics file (PNG, GIF, BMP, JPEG, TIFF).
- **To clipboard** – copy of the current content of 2D window to the Windows clipboard.
- **To DXF** – start export of the current content of 2D window to the 2D DXF file.

3.1.1 DXF export settings

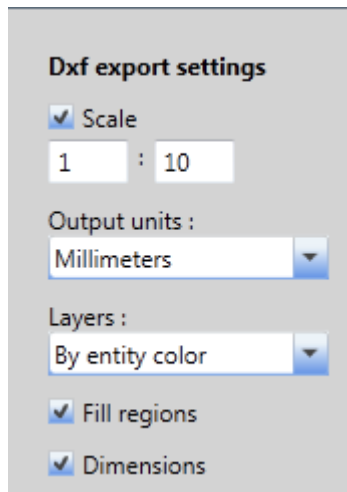

Following export parameters can be set in the Save as dialog when exporting the view to the 2D file:

- **Scale** – if the option is selected, the scale ratio used to create the drawing in exported DXF can be set.
- **Output units** – select units of the drawing in the exported DXF file.
- **Layers** – select the mode of layers generation. Layers can be generated according to the line type, the line thickness, the entity type or the entity color.
- **Fill regions** – switch on/off export of filled regions (otherwise only outlines are exported).
- **Dimensions** – switch on/off export of dimension lines.

3.2 Table editor

Some input data (vertices of general cross-sections, values of internal forces etc.) can be entered using table editor.

Copy to clipboard and paste from clipboard can be used to enter the value to single cell or to fill the range of cells (using shortcuts CTRL-C (CTRL-INS) and CTRL-V (SHIFT-INS)).

	Y [mm]	Z [mm]
1	-750	537
2	-750	357
3	-110	297
4	-110	-713
5	-225	-743
6	-225	-963
7	225	-963
8	225	-743
9	110	-713
10	110	297
11	750	357
12	750	537
*		

- Cells (ranges) can be pasted to the table from the Microsoft Excel table
- When pasting the data to the table the data are inserted to the current position in the table.
- If the number of columns in the clipboard is greater than the number of columns in the target table, the redundant columns are ignored.
- If the number of rows in the clipboard is greater than one, the rows following the current row in the target table are overwritten. If the number of inserted rows is greater than the number of rows in the target table, the required number of new rows is inserted to the target table
- If a range is selected in the target table and the clipboard contains only value of one cell, all cells in the selected range are filled with the same value when pasting from the clipboard.
- To add a new row to the table click cell * in the indexes column or use the keyboard shortcut **CTRL + ENTER** (the last row of the table must be set as current row)

Following keyboard shortcuts can be used when working with the table editor:

- **CTRL + +** - insert a row before the current row.
- **CTRL + ENTER** - append a row to the current row.
- **CTRL + --** - delete the current row.
- **CTRL + A** - select the whole table
- **CTRL + C (CTRL + INS)** – copy the selected cells to the clipboard.
- **CTRL + V (SHIFT + INS)** – paste the clipboard content to the table
- **TAB** – change the current cell by moving forwards through the cells
- **SHIFT + TAB** – change the current cell by moving backwards through the cells
- **<, >, ^, v** - change the current cell by moving left, right, up, down
- **F2** – switch to edit mode of the cell and place the cursor to the end of the current cell. Move to the other cell to finish the edit mode with preserving the changes or push ESC to discard the changes.
- **ESC** – close the edit mode discarding the changes.

4 Creating new project

If IDEA RCS is started from superior application, creating a new project is not available.

A short-cut has been placed on the desktop automatically during the installation. Double click the short-cut to launch the program. The user can **Create a new project** or **Open an existing project** from the list of recently opened projects.

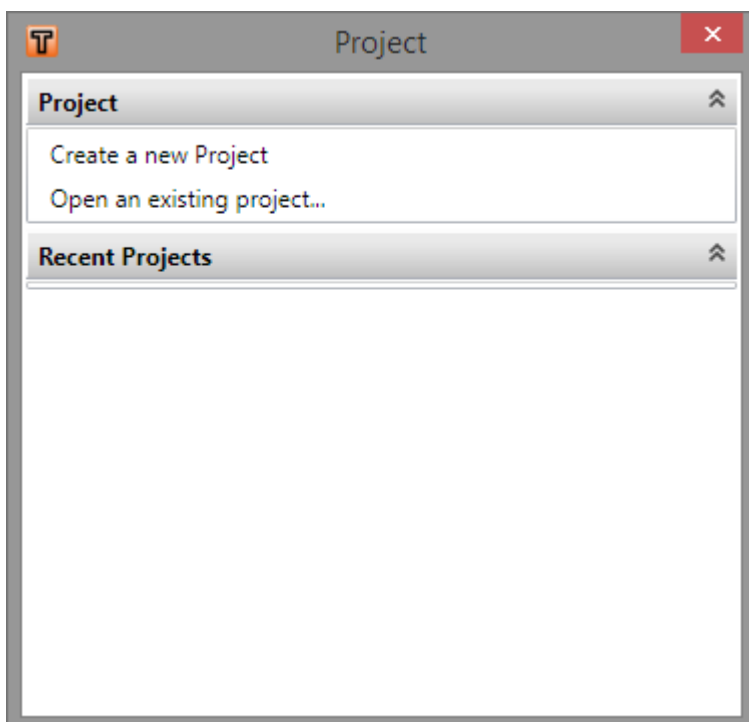

Click **Create new project** to display the dialog for definition of the initial project parameters and initial member type.

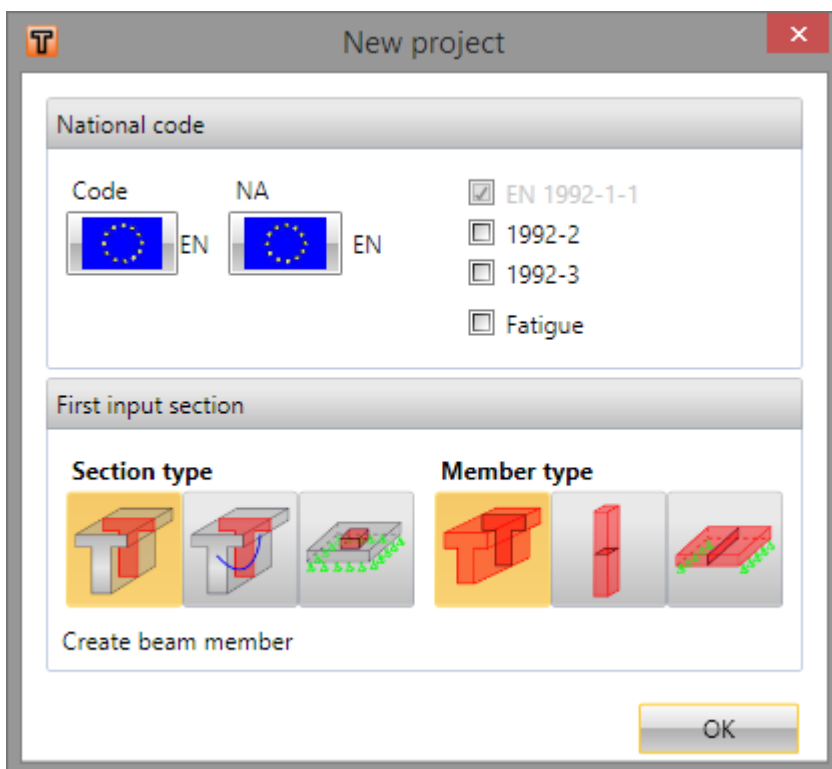

After defining the required default values, choosing the proper member type and clicking **OK**, a new project with the proper member and section is created. The selected section is set as current section – see list **Current section** in **Navigator**.

4.1 Project data and default values setting

To change project data and choose default materials click **Project data** in ribbon group **Settings**. Dialog **Project data** appears with project details and table National code. Project identification data are available in the header.

- **Code** – click to set current code to EC-EN or to load user defined settings of code parameters.
- **NA** – click to load one of available National Annex parameter sets.
- **EN 1992-2** – switch on/off option to check a cross-section according to code EN 1992 2. If EN 1992 2 is selected, data for flexural slenderness check cannot be entered and flexural slenderness check cannot be performed.
- **EN 1992-3** – switch on/off check of cross-sections according to EN 1992-3 Liquid retaining and containment structures.
- **Fatigue** – switch on/off the availability to input fatigue load combinations and to perform the fatigue check.

- **Annex NN** - switch on/off the fatigue check according to the Annex NN. This option is available only if the national code EN 1992 2 is selected.
- **Design working life** – (list-box) setting for value of the Design working life.
- **Exposure classes** – (check-boxes) setting for new members. The Exposure class influences the available materials of concrete and reinforcement
- **Default concrete class** – (list-box) the default concrete grade from the displayed list is assigned to newly input reinforced sections.
- **Default reinforcement steel grade** – (list-box) the default reinforcement grade from the displayed list is assigned to newly entered reinforcement bars and stirrups
- **Default prestressing steel grade** – (list-box) the default prestressing reinforcement grade from the displayed list is assigned to newly input prestressing tendons.

5 Working with sections

Click navigator command **Project summary > Sections** to open the dialog with all defined sections in the current project

In the Main dialog window, sections are arranged as they are created (minimally one section is always available).

The list of loads extremes assigned to the current section is displayed in Data window.

	Section Name	Section Type	Design Member	Member Type	Reinforced Cross-Section	Va
1	S 1	Staged	M 1	Beam	R 1	
2	S 2	Reinforced	M 2	Slab	R 2	

	Extreme Name	Time [d]	Value	Result Status
1	S 1 - E 1	18250,0	250,0	✘
2	S 1 - E 2	28,0	0,0	?

In the Main dialog window it is possible to rename a section in the column **Section name**. In the columns **Design Member** and **Reinforced Cross-section** the appropriate design member data or reinforced cross-section from lists of available member data/reinforced cross-sections in project can be assigned.

If the section is already calculated, the maximum unity check value from all possible checks for all loads extremes is displayed in column **Value**. In the column **Status** the actual check status (OK/NOT OK) is displayed.

Name of loads extreme can be changed in column **Extreme Name** in Data window. Age of concrete is displayed in column **Age**. For each loads extreme maximal value from all checks and corresponding status are displayed in columns **Value** and **Result status**.

Value of age can be edited only for loads extreme, which is assigned to prestressed sections. The value of age describes position on time axis, in which check is performed.

Ribbon groups **Import**, **Set**, **Section**, **Extreme**, **Design member**, **Reinforced section**, **Calculation**, **Report** and **Print** are available.

5.1 Ribbon group Set

If IDEA RCS is started from superior application, this ribbon group is not available.

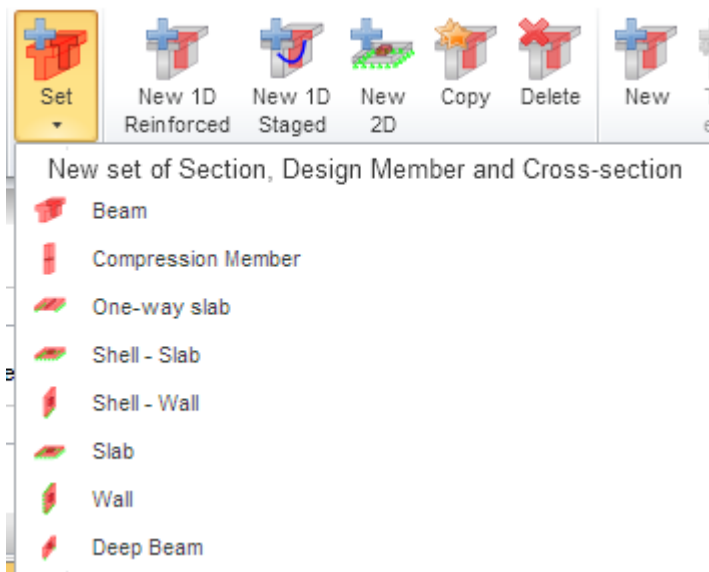

Click **Set** to display menu with commands for fast input of new section with new reinforced section, new member data and new loads extreme.

- **Beam** – adds a new 1D-member section with type Beam with a new reinforced section
- **Compression member** – adds a new 1D-member section with type Compression member with a new reinforced section.
- **One-way slab** - adds new 1D-member section with member type One-way slab with a new reinforced section.
- **Shell-Slab** - adds a new 2D-member section with member type Shell-slab (combination of membrane and bending forces, detailing rules according slabs) with a new reinforced section.
- **Shell-Wall** - adds a new 2D-member section with member type Shell-wall (combination of membrane and bending forces, detailing rules according walls) with a new reinforced section
- **Slab** - adds a new 2D-member section with member type Slab (bending forces) with a new reinforced section.
- **Wall** - adds a new 2D-member section with member type Wall (membrane forces) with a new reinforced section.
- **Deep beam** - adds a new 2D-member section with member type Deep beam (membrane forces) with a new reinforced section.

5.2 Ribbon group Import

If IDEA RCS is started from superior application, this ribbon group is not available.

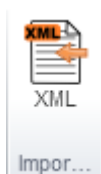

Click XML to start import of sections, reinforced cross-sections and loads extremes from XML file, which was exported from program SCIA Engineer– see [Import from XML file](#).

If XML file contains result tables for different types of combinations, load cases and result classes, program IDEA RCS cannot assign such results to particular load effects automatically. In this case a dialog with a list of all load types from imported result tables and result types from SCIA Engineer can be assigned to appropriate load types used in IDEA RCS.

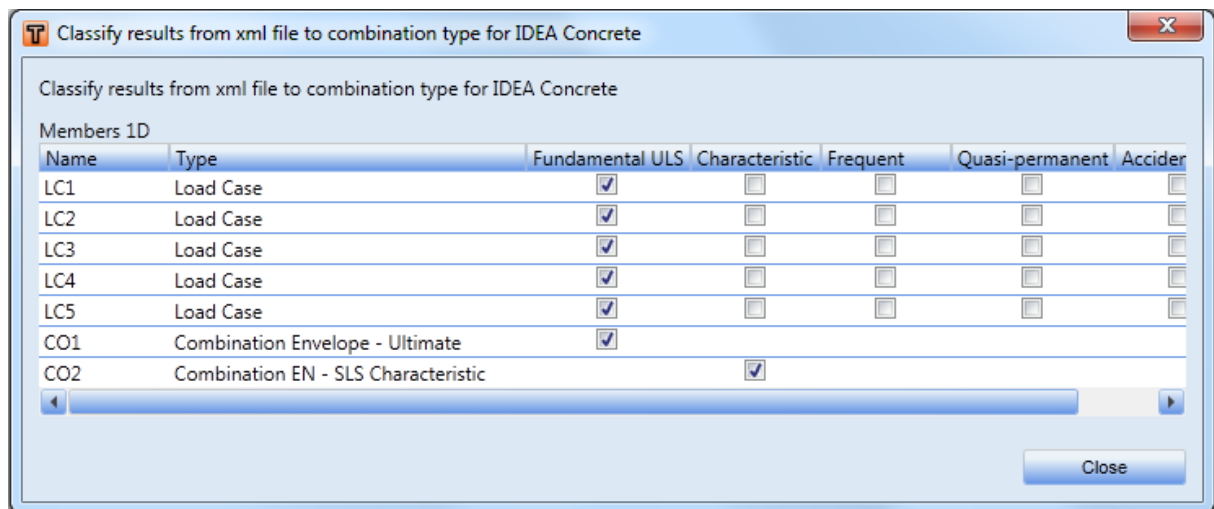

Each row of table represents one load effect, which was found in imported XML file. The conversion table contains following columns:

- **Name** – names of imported load cases, combinations or result classes are displayed in this column
- **Type** – type of load, which was found for particular load name, is displayed in this column.
- **Fundamental ULS, Characteristic, Quasi-permanent, Accidental** – if checkbox in particular column is checked, imported result from appropriate row is assigned to selected load effect type in IDEA RCS.

5.3 Ribbon group Section

If IDEA RCS is started from superior application, this ribbon group is not available.

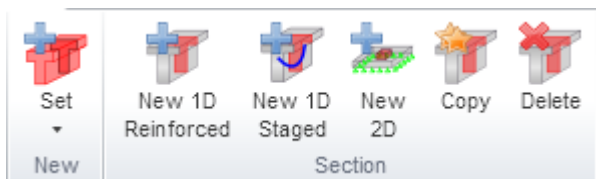

Click buttons in ribbon group **Section** to add, copy or remove sections. The existing member (or newly created) and reinforced cross-section can be assigned to a new section.

- **New 1D Reinforced** - add a new section for a 1D-member reinforced with concrete reinforcement – see **New section input**.
- **New 1D staged** - add a new staged section for a 1D-member – see **New section input**.
- **New 2D** - add a new section for a 2D-member – see **New section input**.
- **Copy** – copy the defined sections including assigned loads extremes.
- **Delete** – delete the defined sections including assigned loads extremes.
- **Explode tapered** – explode section, which was generated from members with haunches, to separate sections. This option can be used only for data stored from IDEA RCS, which was launched as module from superior linked application.

5.3.1 New section input

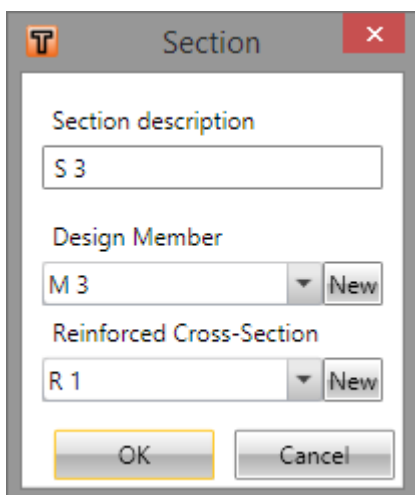

Parameters of new section:

- **Section description** – input/edit name of a section.
- **Design member** – selection of a design member from the list-box of design members, the selected design member is assigned to a new section. Only those design members are available which are according the section type, being only 1D-members or 2D-members.
- **New** – launches the input of a new design member into the list of design members.
- **Reinforced cross-section** – selection of reinforced cross-section from a list-box of cross-sections, selected cross-section is assigned to new section. List of available reinforced cross-sections is filtered according to selected member in Design Member list-box (i.e. for design member Compression member only those cross-sections can be selected whose shape and reinforcement is conforming to requirements for compression members)
- **New** – launches the input of new reinforced cross-section into list of reinforced cross-sections.

5.4 Ribbon group Extreme

If IDEA RCS is started from superior application, this ribbon group is not available.

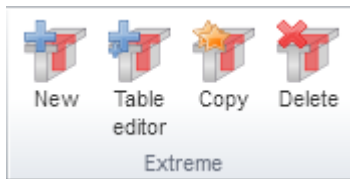

Click buttons in ribbon group **Extreme** to add, to copy or to remove load extremes.

- **New** – adds new load extreme into current section.
- **Table editor** – start editing of load extremes using the table editor – see [Editing load extremes using table editor](#).
- **Copy** – copies selected load extreme.
- **Delete** – deletes selected load extreme.

5.4.1 Editing load extremes using table editor

To edit the content of internal forces extremes for the current section click **Table editor** in the ribbon group **Extreme**.

The dialog contains tabs with tables for particular load combination types. One load extreme of current section represents one row in the table.

The edit of load extremes using table editor is not available for prestressed sections.

The table editor is described in [Table editor](#).

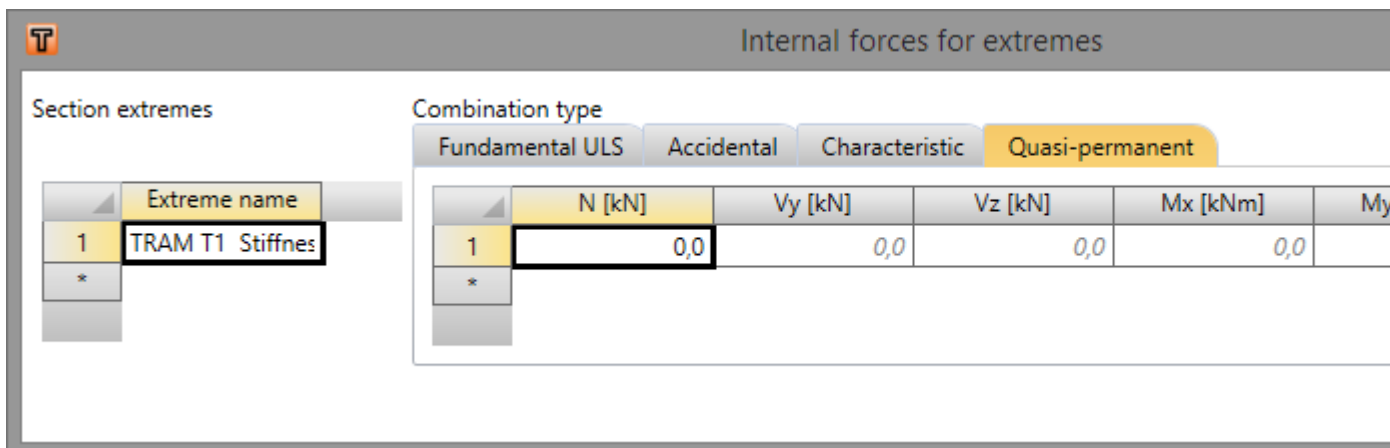

5.5 Ribbon group Design member

If IDEA RCS is started from superior application, this ribbon group is not available.



- **New 1D** - adds a new 1D design member.
- **New 2D** - adds a new 2D design member.
- **Delete unused** – deletes inserted design members which are not assigned to any section.

5.5.1 New design member input

The dialog provides setting of the design member parameters for the related section. The content of dialog differs according to type of design member. For Beam and One-way slab design members, the parameters for flexural slenderness check can be specified on tab **Flexural slenderness**.

Relative humidity	65	%
Creep coefficient	Calculated	
Member type	Beam	
Structural member importance	Major	
Redistribution of moments	<input type="checkbox"/>	
Reduction of moments	<input type="checkbox"/>	
Reduction of shear force	<input type="checkbox"/>	
Limited interaction check	<input type="checkbox"/>	

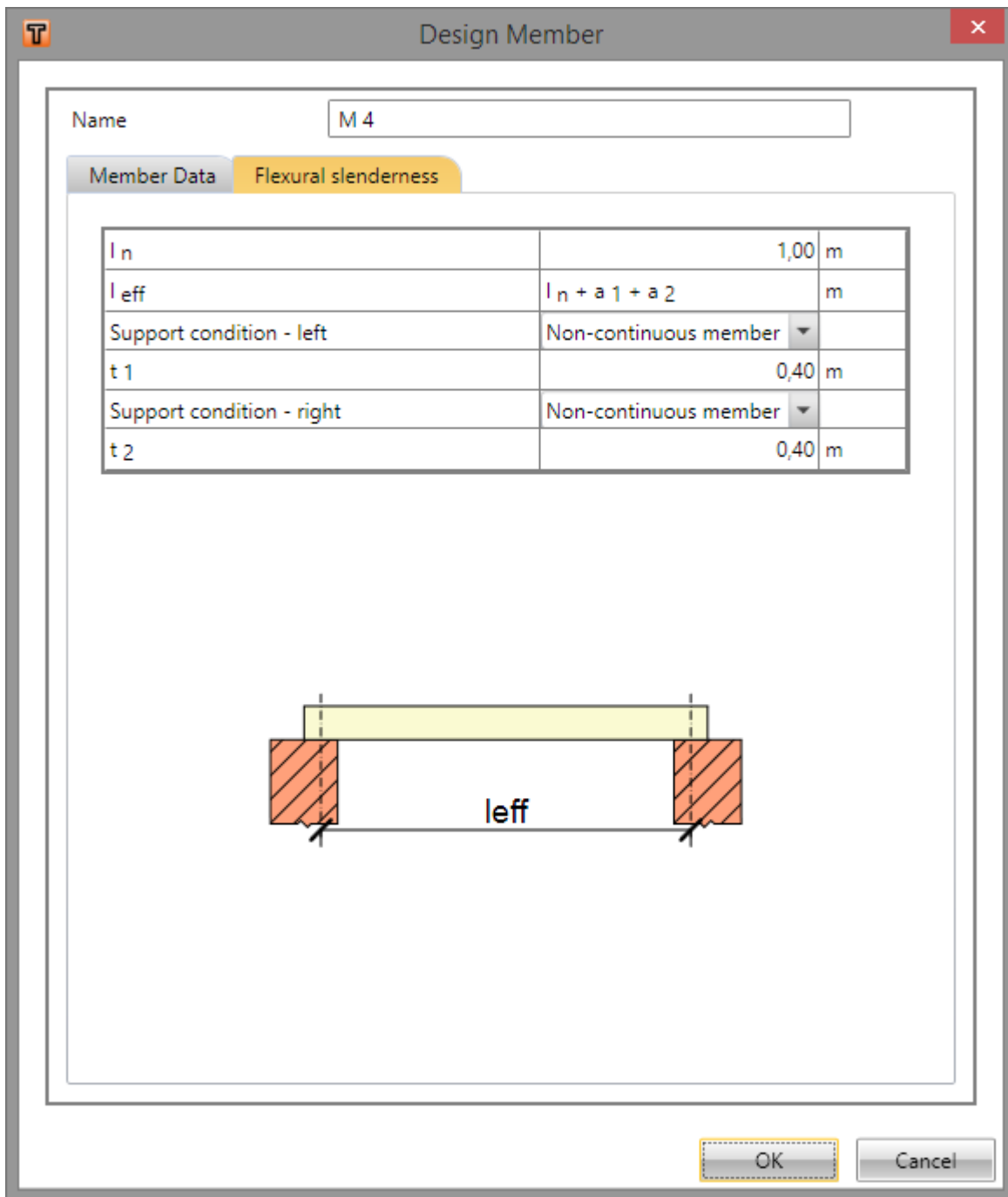

5.6 Ribbon group Reinforced cross-section

If IDEA RCS is started from superior application, this ribbon group is not available.

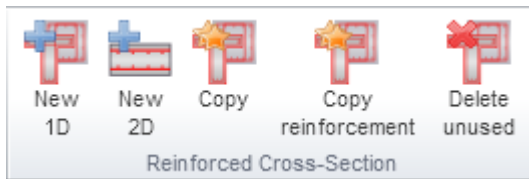

Click buttons in ribbon group **Reinforced cross-section** to add, to copy or to remove reinforced cross-sections.

- **New 1D** - adds a new reinforced cross-section for members 1D.
- **New 2D** - adds a new reinforced cross-section for members 2D
- **Copy** – copy of inserted reinforced cross-sections.
- **Copy reinforcement** – copy reinforcement from one reinforced section to another one
- **Delete unused** – deletes existing reinforced cross-sections which are not assigned to any section.

5.6.1 New reinforced cross-section

Click **New 1D** or **New 2D** in ribbon group **Reinforced cross-section** to input new reinforced section. Dialog for input of reinforced cross-section name appears. Other data (shape, longitudinal and shear reinforcement) are specified later using navigator commands Reinforced cross-section.

5.6.2 Copy of reinforced section

To copy reinforced section click **Copy** in ribbon group **Reinforced section**.

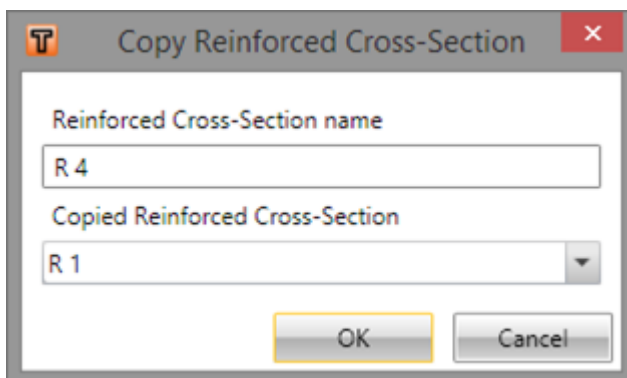

Input name of newly created reinforced section to the edit box **Reinforced cross-section name**.

Select the reinforced section to be copied in the list **Copied reinforced cross-section**.

5.6.3 Copy of reinforcement

Click **Copy reinforcement** in the ribbon group **Reinforced section** to copy the reinforcement from one reinforced section to other one.

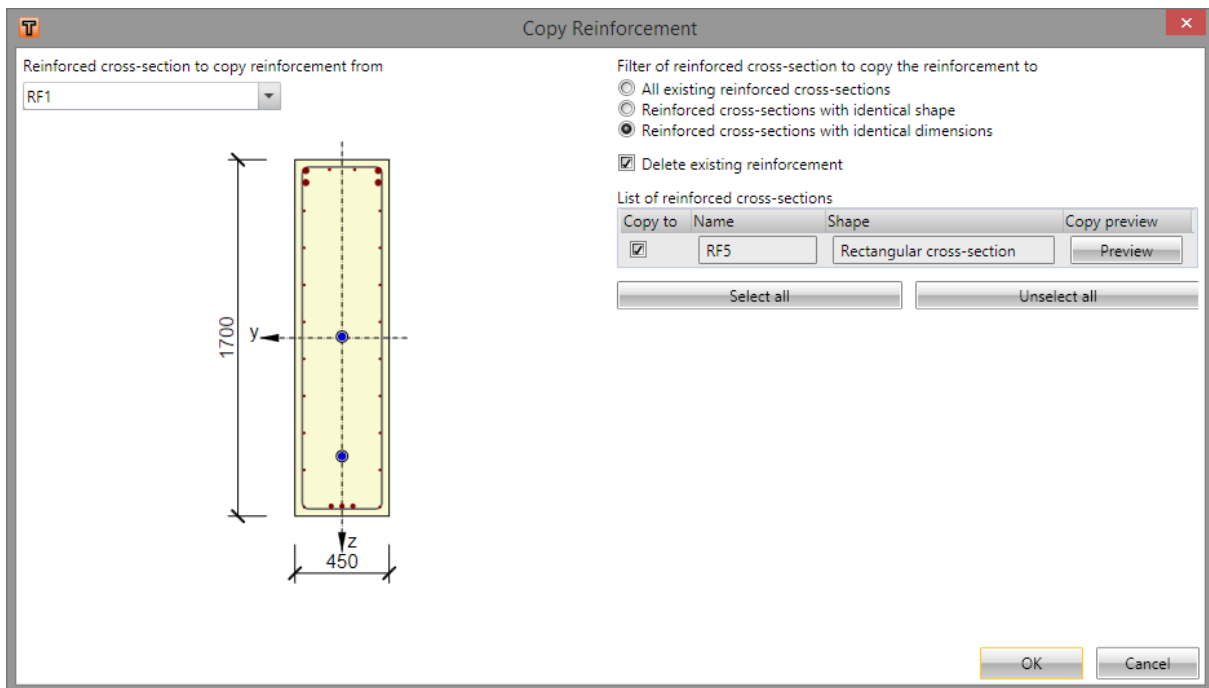

- **Reinforced cross-section to copy reinforcement from** – in the list, select the source reinforced cross-section to copy the reinforcement from
- **Filter of reinforced cross-section to copy the reinforcement to** – according to the filter the **List of reinforced cross-sections** contains suitable reinforced sections, to which is possible to copy the reinforcement from the source reinforced cross-section.
 - **All existing reinforced cross-sections** – turn this option on to display all existing reinforced cross-section in the **List of reinforced cross-sections**.
 - **Reinforced cross-sections with identical shape** – turn this option on to display reinforced cross-sections, which are of the same cross-section type as the source reinforced section, in the **List of reinforced cross-sections**.
 - **Reinforced cross-sections with identical dimension** – turn this option on to display reinforced cross-sections, which are of the same cross-section type and of the same dimensions as the source reinforced section, in the **List of reinforced cross-sections**.
- **Delete existing reinforcement** – turn this option on to delete the existing reinforcement from the target reinforced section before copying. If the option is off, the copied reinforcement is added to the old one.
- **List of reinforced sections** – the list contains suitable target reinforced sections, filtered according to the current filter settings. Columns in the list:
 - **Copy to** – switch on/off to copy the reinforcement to particular target reinforced section
 - **Name** – display name of target reinforced section.
 - **Shape** – display name of shape of target reinforced section.
 - **Preview** – click to display the preview of result of copy of reinforcement from the source to the target reinforced section.
- **Select all** – select all checkboxes in the column **Copy to**.
- **Unselect all** - unselect all checkboxes in the column **Copy to**.

Click **OK** to copy the reinforcement according to the current settings and to close the dialog.

5.7 Ribbon group Calculation

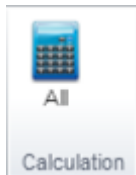

- **All** – calculates all sections. All sections, which had been correctly user defined, are calculated. Overall report is displayed afterwards.

5.8 Ribbon group Report

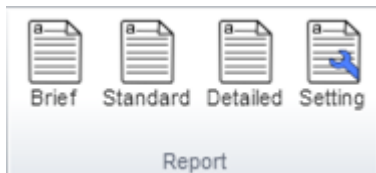

Use commands in ribbon group **Report** to generate the report and to setup the report content:

- **Brief** – shows brief report for sections with **Print** option enabled in report settings.
- **Standard** – shows standard report for sections with **Print** option enabled in report settings.
- **Detailed** – shows detailed report for sections with **Print** option enabled in report settings.
- **Setting** – shows the report setting dialog for the selection of sections to be printed and the selection of chapters to be printed for each section - see **Global report setting**.

5.8.1 Global report setting

Here, you can choose the chapters you want to print. You can make a detailed print setting for each section independently.

Section Name	Detailed Settings	Print
TRAM T1 Bilineár	P 1	<input checked="" type="checkbox"/>
TRAM T1 Šířka Trhlin	P 1	<input checked="" type="checkbox"/>
TRAM T1 Stiffness	P 1	<input checked="" type="checkbox"/>
TRAM T1 Shear, Torsion, Interaction	P 1	<input checked="" type="checkbox"/>
Sloup - jmenovité tuhosti	P 1	<input checked="" type="checkbox"/>
Sloup - jmenovité křivosti	P 1	<input checked="" type="checkbox"/>

- **Table of contents** – turns on/off the table of content to be printed in the report.
- **Project data** – turns on/off the chapter about general project information entered in **Project data** dialog to be printed in the report.
- **List of sections** – turns on/off the chapter about overall results of all checked sections to be printed in the report. This setting is taken into account in Standard and Detailed report.
- **Code setting** – turns on/off the chapter about code dependent variables to be printed in the report. This setting is taken into account in Detailed report only.
 - **User defined values only** – turns on/off limited print of code settings to user changed values only.







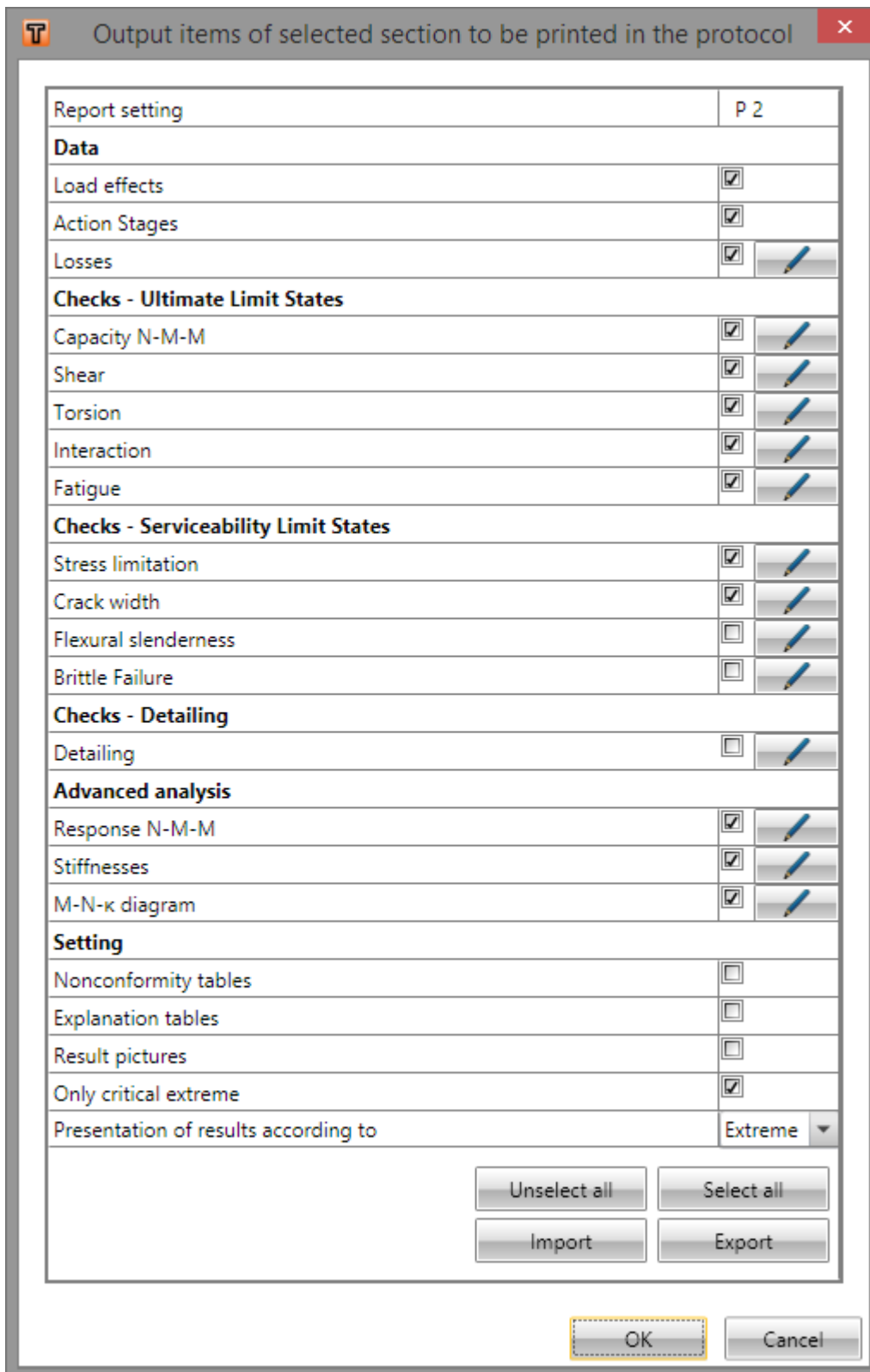







- **List of members** – turns on/off the chapter about member data to be printed in the report. This setting is taken into account in Detailed report only.
- **List of reinforced cross-sections** - turns on/off the chapter about reinforced cross-section to be printed in the report. This setting is taken into account in Detailed report only.
- **List of materials** - turns on/off the chapter about material characteristics to be printed in the report. This setting is taken into account in Detailed report only.
- **Table of sections** contains list of sections defined in the project. Columns in the table:
 - **Section name** – name of the section.
 - **Detailed settings** – list-box of available Detailed settings. The setting is used in report for selected section. Selected setting can be changed by clicking edit-button  - see **Detailed report setting**.
 - **Print** – turns on/off the print of output for the section into report.
- **Select all to print** – turns on the **Print** option for all sections in the list
- **Unselect all to print** – turns off the **Print** option for all sections in the list
- **New setting** – adds new detailed print setting to existing detailed report settings.

5.8.2 Detailed report setting

The existing report settings can be changed by clicking  or new report settings can be created by clicking **New settings** in **Report settings** dialog.



Output items of selected section to be printed in the protocol

Report setting		P 2
Data		
Load effects	<input checked="" type="checkbox"/>	
Action Stages	<input checked="" type="checkbox"/>	
Losses	<input checked="" type="checkbox"/>	
Checks - Ultimate Limit States		
Capacity N-M-M	<input checked="" type="checkbox"/>	
Shear	<input checked="" type="checkbox"/>	
Torsion	<input checked="" type="checkbox"/>	
Interaction	<input checked="" type="checkbox"/>	
Fatigue	<input checked="" type="checkbox"/>	
Checks - Serviceability Limit States		
Stress limitation	<input checked="" type="checkbox"/>	
Crack width	<input checked="" type="checkbox"/>	
Flexural slenderness	<input type="checkbox"/>	
Brittle Failure	<input type="checkbox"/>	
Checks - Detailing		
Detailing	<input type="checkbox"/>	
Advanced analysis		
Response N-M-M	<input checked="" type="checkbox"/>	
Stiffnesses	<input checked="" type="checkbox"/>	
M-N- κ diagram	<input checked="" type="checkbox"/>	
Setting		
Nonconformity tables	<input type="checkbox"/>	
Explanation tables	<input type="checkbox"/>	
Result pictures	<input type="checkbox"/>	
Only critical extreme	<input checked="" type="checkbox"/>	
Presentation of results according to		Extreme ▾

Unselect all Select all

Import Export

OK Cancel

The name of report settings can be defined in **Report setting** edit box.

Clicking edit button  at individual checks enables to select tables and pictures to be printed for the appropriate check. The picture size can be defined also.

5.8.2.1 Group Data

It adds tables of input data which can be inserted to Report for current section. The table of load effects according to input described in **Load effects input** can be added. Automatically, for compression members it adds the table with recalculated values of inner forces, biaxial bending and stiffness.

5.8.2.2 Group Checks

It adds results of calculated checks activated to current section. For each check it is possible to change print setting (setting of tables and pictures).

5.8.2.3 Group Setting

Turning on/off options in group setting shows/hides the items in the report.

- **Nonconformities tables** – if the option is turned off then no nonconformity table is shown in the report. In other case the tables are displayed if they haven't been switched off in detailed setting.
- **Explanation tables** – if the option is turned off then no explanation table is shown in the report. In other case the tables are displayed if they haven't been switched off in detailed setting.
- **Result pictures** – if the option is turned off then no picture with graphical presentation of results is shown in the report. In other case pictures are displayed if they haven't been switched off in detailed setting.
- **Only critical extreme** – if the option is turned on for section with more loads extremes, the result is printed only for loads extreme, which causes the maximal value of exploitation. Otherwise results are printed for each loads extreme in section.

5.8.2.4 Detailed report setting for check chapters

The screenshot shows a dialog box titled "Output items of selected check to be printed in the protocol". It contains the following sections:

- Tables:**
 - Detailed results in components: Extremes (dropdown menu)
 - Nonconformities table:
 - Explanations table:
- Pictures:**

Picture Name	Print
Stress and strain distributions in the cross-section	<input checked="" type="checkbox"/>
Stress and strain distributions in the cross-section in 3D view	<input type="checkbox"/>
Resultant forces in the cross-section in 3D view	<input type="checkbox"/>
State of stress in extremely loaded concrete fibre in compression	<input type="checkbox"/>
State of stress in extremely loaded reinforcement bar in tension	<input type="checkbox"/>
- Height and width of pictures:**

Height of pictures	350
Width of pictures	500

At the bottom of the dialog are "OK" and "Cancel" buttons.

- **Detailed results in components** – select the range of results for print:
 - **No print** – detailed results are not printed.
 - **Extremes** – detailed results are printed in extreme fibres of cross-section components.
 - **All points** – detailed results are printed for all fibres of components.
- **Nonconformity table** – turns on/off the print of nonconformity table into the report for edited check.
- **Explanation table** – turns on/off the print of table with explanation of symbols into report for edited check.
- **Pictures** – there is a list of available graphical presentations of results for the current check. The print of the picture can be set on/off.
- **Height and width of pictures** – setting for picture size in pixels.

6 Design members

Click navigator command **Project summary > Design members** to display and edit all design members in project.

Ribbon group **Design members** is available.

The screenshot shows the main window of the IDEA RCS software. On the left, a table lists design members with their names, values, and result statuses. On the right, the 'Design member M 1' properties are displayed, including a list of associated sections and a detailed 'Member Data' panel for 'Flexural slenderness'.

	Name	Value	Result Status
1	M 1	1000,0	✘
2	M 2	160,0	✘
3	M 3	90,7	✔

Design member: M 1
List of sections associated with design member: TRAM T1 Bilineár, TRAM T1 Šířka Trhlin, TRAM T1 Stiffness

Member Data Flexural slenderness

Exposure Classes

<input type="checkbox"/> No corrosion (X0)	<input checked="" type="checkbox"/> Carbonation XC1	<input type="checkbox"/> Chlorides XD1
<input type="checkbox"/> Chlorides from sea XS1	<input type="checkbox"/> Freeze/Thaw Attack XF1	<input type="checkbox"/> Chemical Attack XA1

Relative humidity	70 %
Creep coefficient	Calculated
Member type	Beam
Structural member importance	Major
Redistribution of moments	<input type="checkbox"/>
Reduction of moments	<input type="checkbox"/>
Reduction of shear force	<input type="checkbox"/>
Limited interaction check	<input type="checkbox"/>

A table with list of design members in project and corresponding check results is displayed in the left part of the main window. The list of sections, to which is the current design member assigned, and the tabs of design member properties corresponding to the design type, are displayed in the right part of the main window.

Columns of the design members table:

- **Name** – input name of the design member.
- **Value** – extreme value of check of all sections, to which is the design member assigned.
- **Result status** – overall status of check of all sections, to which is the design member assigned.

6.1 Design member data common to all members

General data of the current design member can be modified on the tab Member data (the same parameters are shown as described in **New design member input**).

Member Data Flexural slenderness

Exposure Classes

<input type="checkbox"/> No corrosion (X0)	<input checked="" type="checkbox"/> Carbonation XC1	<input type="checkbox"/> Chlorides XD1
<input type="checkbox"/> Chlorides from sea XS1	<input type="checkbox"/> Freeze/Thaw Attack XF1	<input type="checkbox"/> Chemical Attack XA1

Relative humidity	70 %
Creep coefficient	Calculated
Member type	Beam
Structural member importance	Major
Redistribution of moments	<input type="checkbox"/>
Reduction of moments	<input type="checkbox"/>
Reduction of shear force	<input type="checkbox"/>
Limited interaction check	<input type="checkbox"/>

The options to switch on/off taking into account redistribution and reduction are available only for design members of type **Beam** and **One-way slab**.

6.2 Compression member data

If the type of current design member is Compression member, the compression member properties can be modified on the tab **Imperfections, 2nd order**.

Member Data		Imperfections, 2nd order	
Length of compression member	5	m	
Effective length	Acc. to supports		
Restraint perpendicular to an axis	y		z
End	Free	Rigid	
Beginning	Rigid	Rigid	
Effect of imperfections and 2nd order	Calculated		
Geometric imperfection			
Use for ULS	<input checked="" type="checkbox"/>		
Use for SLS	<input type="checkbox"/>		
Effect considered	Isolated member		
Direction of imperfections	From code setting		
Second order effect			
Analysis of second order effects	<input checked="" type="checkbox"/>		
Braced member to y axis	<input type="checkbox"/>		
Braced member to z axis	<input checked="" type="checkbox"/>		
Method of analysis	Nominal stiffness		
Factor c0 to y axis	User defined		
c0y	9,60 -		
Factor c0 to z axis	User defined		
c0z	9,60 -		

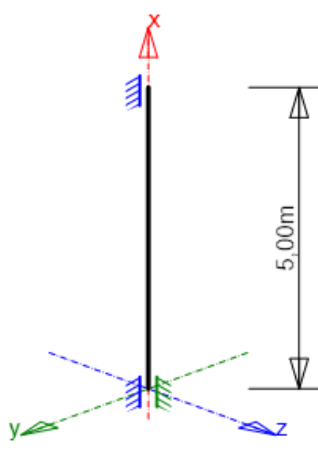

6.3 Data for Flexural slenderness calculation

If the type of current design member is **Beam** or **One-way slab**, data for flexural slenderness calculation can be modified on tab **Flexural slenderness**.

Member Data	Flexural slenderness
l_n	6 m
l_{eff}	$l_n + a_1 + a_2$ m
Support condition - left	Non-continuous member ▼
t_1	0,30 m
Support condition - right	Non-continuous member ▼
t_2	0,30 m

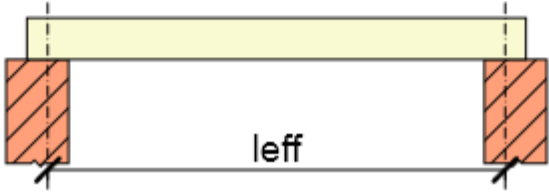

The diagram shows a horizontal yellow beam supported by two vertical orange columns with diagonal hatching. The beam is positioned between the columns. A dimension line below the beam indicates the effective length, labeled as l_{eff} . The columns are shown as rectangular blocks with diagonal hatching, and the beam is shown as a solid yellow rectangle.

6.3.1 Ribbon group Design member

See [Ribbon group Design Member](#).

7 Reinforced cross-sections

Click navigator command **Project summary > Reinforced cross-sections** to display and edit all reinforced cross-sections in project.

Ribbon group **Reinforced cross-section** is available.

Main

	Name	Value	Result Status
1	R 1	100,0	✓
2	R 2	1000,0	✗
3	R 3	160,0	✗

Reinforced cross-section: R 1
List of sections associated with reinforced cross-section: TRAM T1 Bilineár, TRAM T1 Šířka Trhlin,

A table with list of reinforced cross-sections in project and corresponding check results is displayed in the left part of the main window. The list of sections, to which is the current reinforced section assigned, and the picture of current reinforced cross-section are displayed in the right part of main window.

Columns of the **Reinforced cross-sections**:

- **Name** – input name of the reinforced cross-section.
- **Value** – extreme value of check of all sections, to which is the reinforced cross-section assigned.
- **Result status** – overall status of check of all sections, to which is the reinforced cross-section assigned.

7.1 Ribbon group Reinforced cross-section

See [Ribbon group Reinforced cross-section](#).

8 Cross-section shape

For the current section (selected in **Current section** list in the top part of Navigator window) navigator command **Current section & Extreme > Cross-section** launches the input of cross-section shape.

Ribbon groups **New cross-section**, **Openings**, **Shift origin**, **Import – Export**, **Dimension lines** and **Calculation** are available.

8.1 Input of new cross-section

If IDEA RCS is started from superior application, input of new cross-section may not be available.

Ribbon group **New cross-section** contains icons of all the available cross-sectional shapes. Click required shape to launch the dialog for input of cross-sectional parameters. Available shapes are filtered according to member type of current member (beam, compression member, one-way slab, 2D members).

Cross-sections available for beam members:

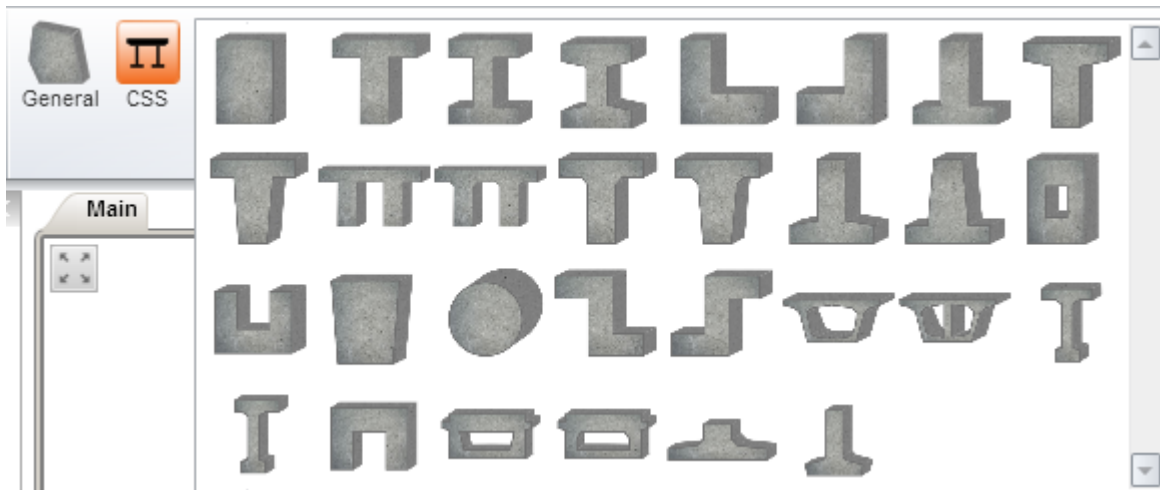

Cross-sections available for compression members:



Cross-sections available for staged sections (license for time dependent analysis is required):

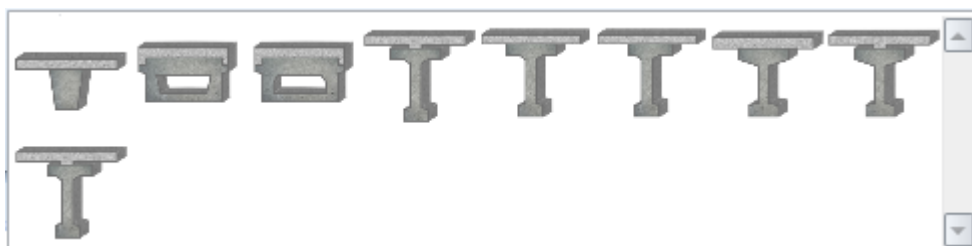

8.2 General cross-sections

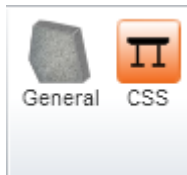

Click **General** or **CSS** in ribbon group **New cross-section** to define new general cross-section:

- **General** – input general one-component cross-section defined by cross-section vertices. Holes in the cross-section can be defined too – see **Input of general section by coordinates of vertices**. Neither staged nor composite cross-section can be defined this way.
- **CSS** – start IDEA CSS plug-in module, in which the general multi-components staged cross-section can be defined – see the user guide for IDEA CSS. The command is available only if the license for IDEA CSS is available.

8.3 Cross-section dimensions input

Dialog with geometrical parameters of the cross-section appears after clicking the required cross-section icon in the ribbon group **New cross-section**. The dialog content depends on the shape of the selected cross-section.

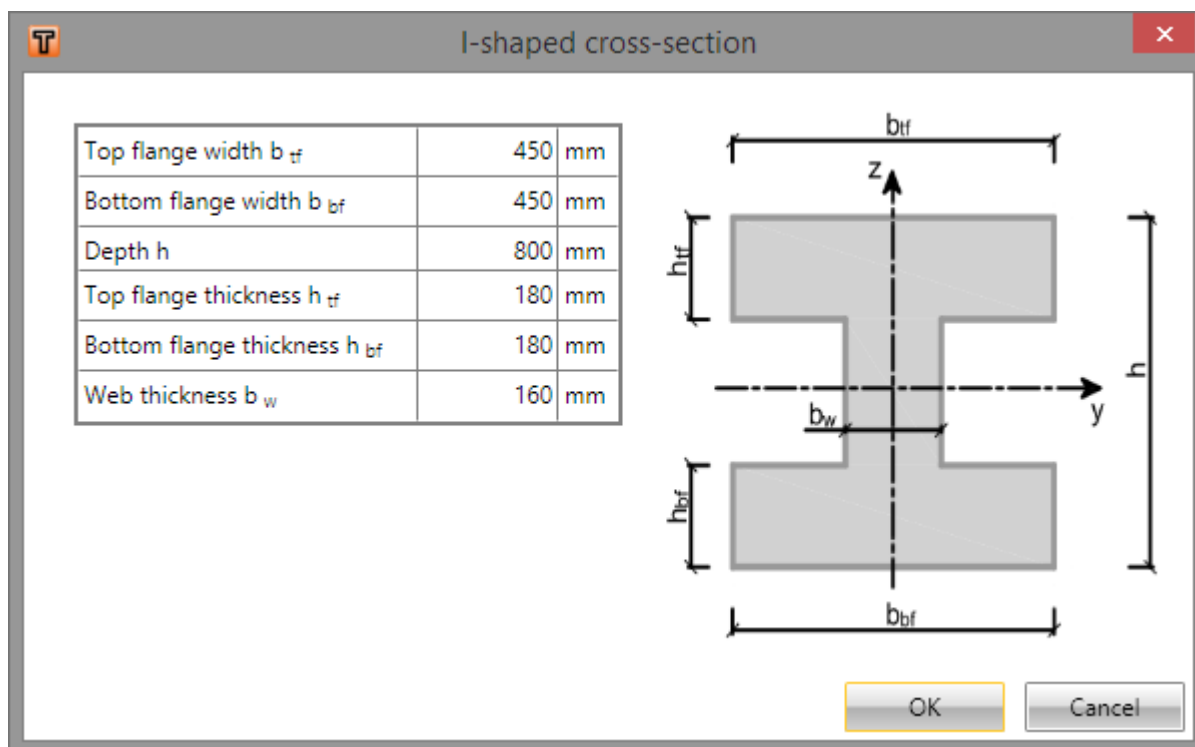

Input the required dimensions and click **OK** to input the cross-section. New cross-section is drawn in the Main window.

8.4 Input of general section by coordinates of vertices

If IDEA RCS is started from superior application, input of general cross-section and its components may not be available.

Click **General** in ribbon group **New cross-section** to input an one-component general cross-section defined by coordinates of vertices.

New general shape is defined by table of vertices coordinates – see **Table editor**.

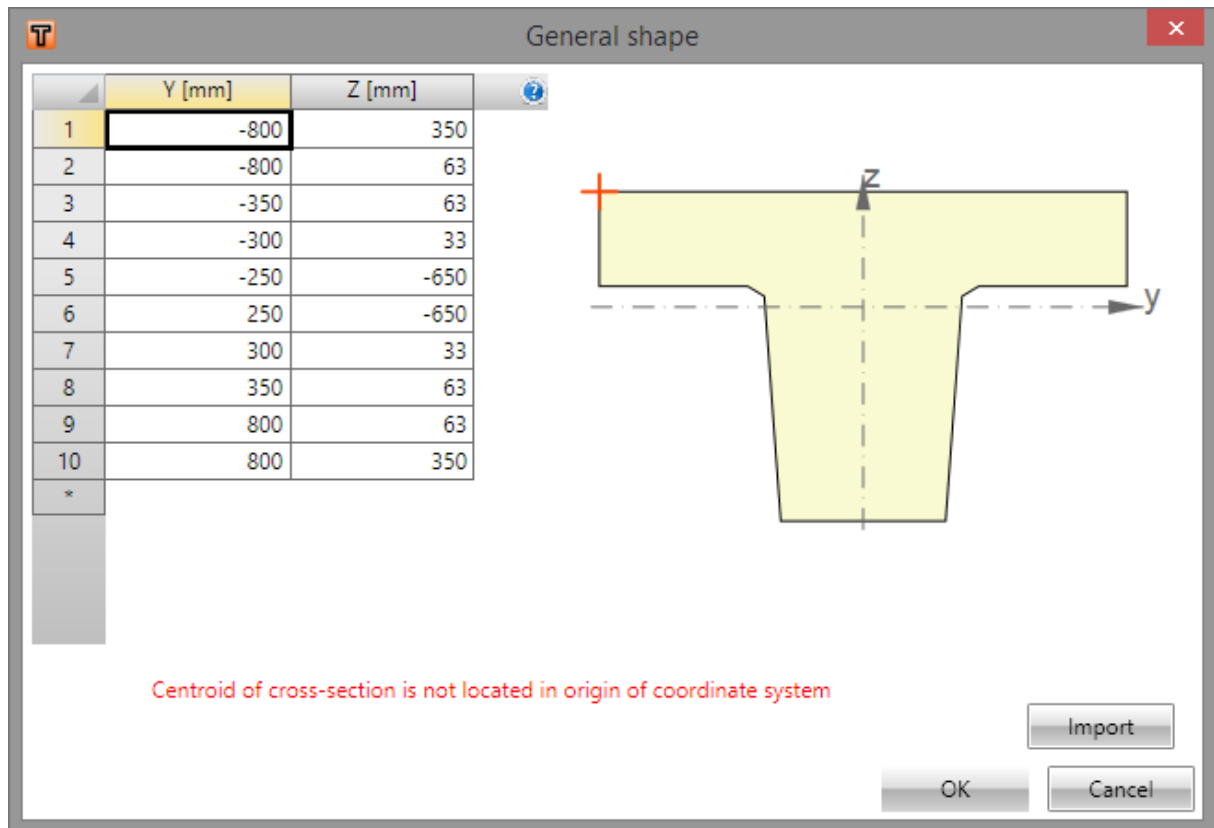

Dialog options:

- **Import** – click to import vertex coordinates from text or .NAV file - see more in **Format of text files for import and export**.

8.4.1 Input of openings into general cross-section

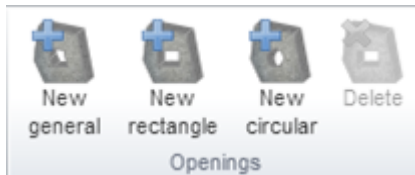

To input new openings into general cross-section use commands on ribbon group **Openings**. This ribbon group is available after shape of general cross-section has been defined.

- **New general** - start input of new opening defined by coordinates of vertices.
- **New rectangle** - start input of new rectangular opening.
- **New circular** - start input of new circular opening.
- **Delete** - delete the current opening.

8.4.2 New general opening

To start input of new opening with general shape click **New general** in ribbon group **Openings**.

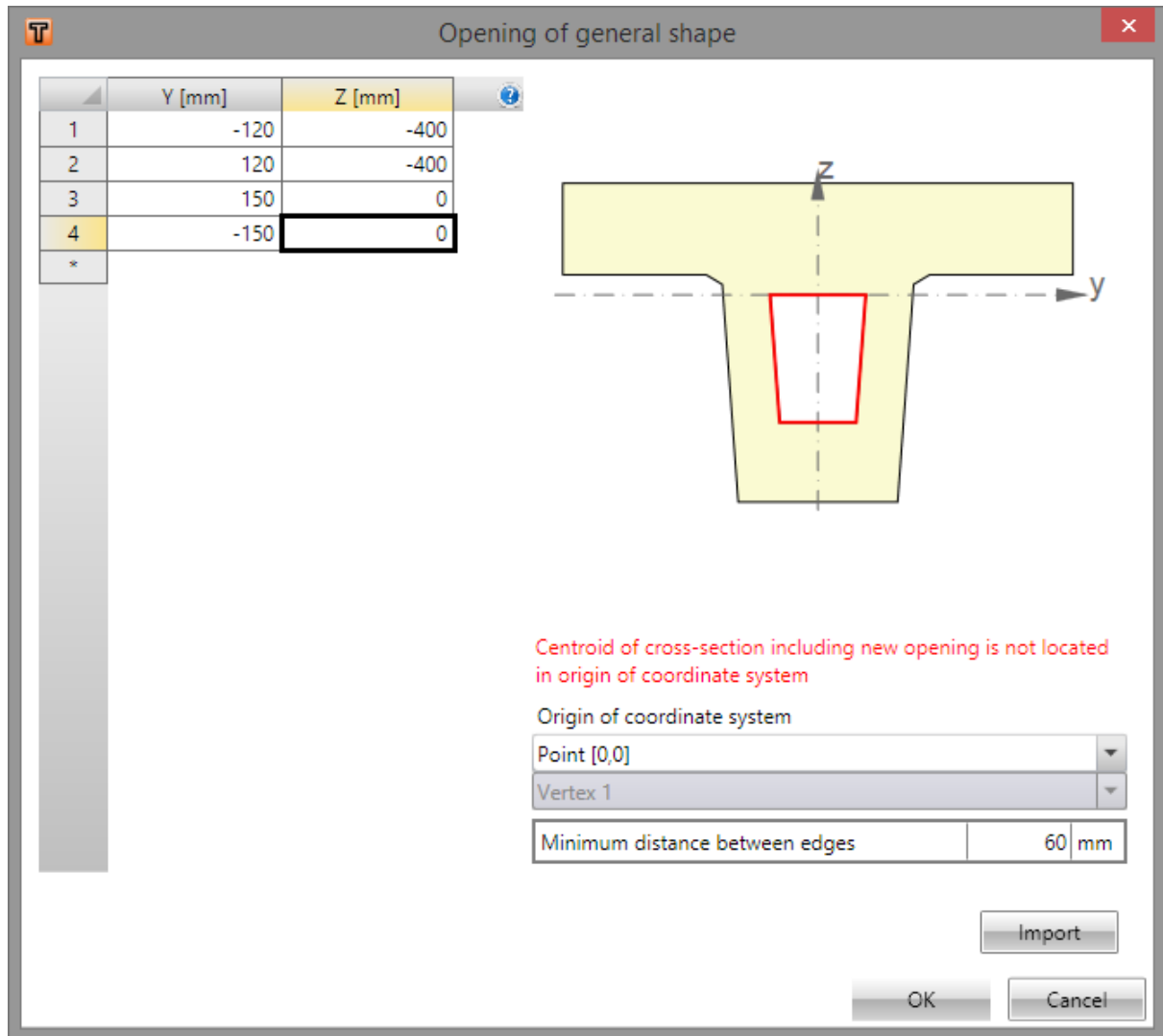

The opening of general shape is defined by table of vertex coordinates – see **Table editor**.

Dialog options:

- **Origin of coordinate system** – defined vertex coordinates are related to point, which can be selected in the list. Choose from following options:
 - **Point [0,0]** – vertex coordinates are related to origin of cross-section coordinate system
 - **Cross-section vertex** – vertex coordinates are related to vertex, which is selected in list below.
- **Minimum distance between edges** – input minimal allowed distance between edges. If distance between any edges is less than the limit value, it is not possible to insert opening into cross-section.
- **Import** – click to import vertex coordinates from text or .NAV file - see **Format of text files for import and export**.

8.4.3 New rectangular opening

To start input of new opening with rectangular shape click **New rectangle** in ribbon group **Openings**.

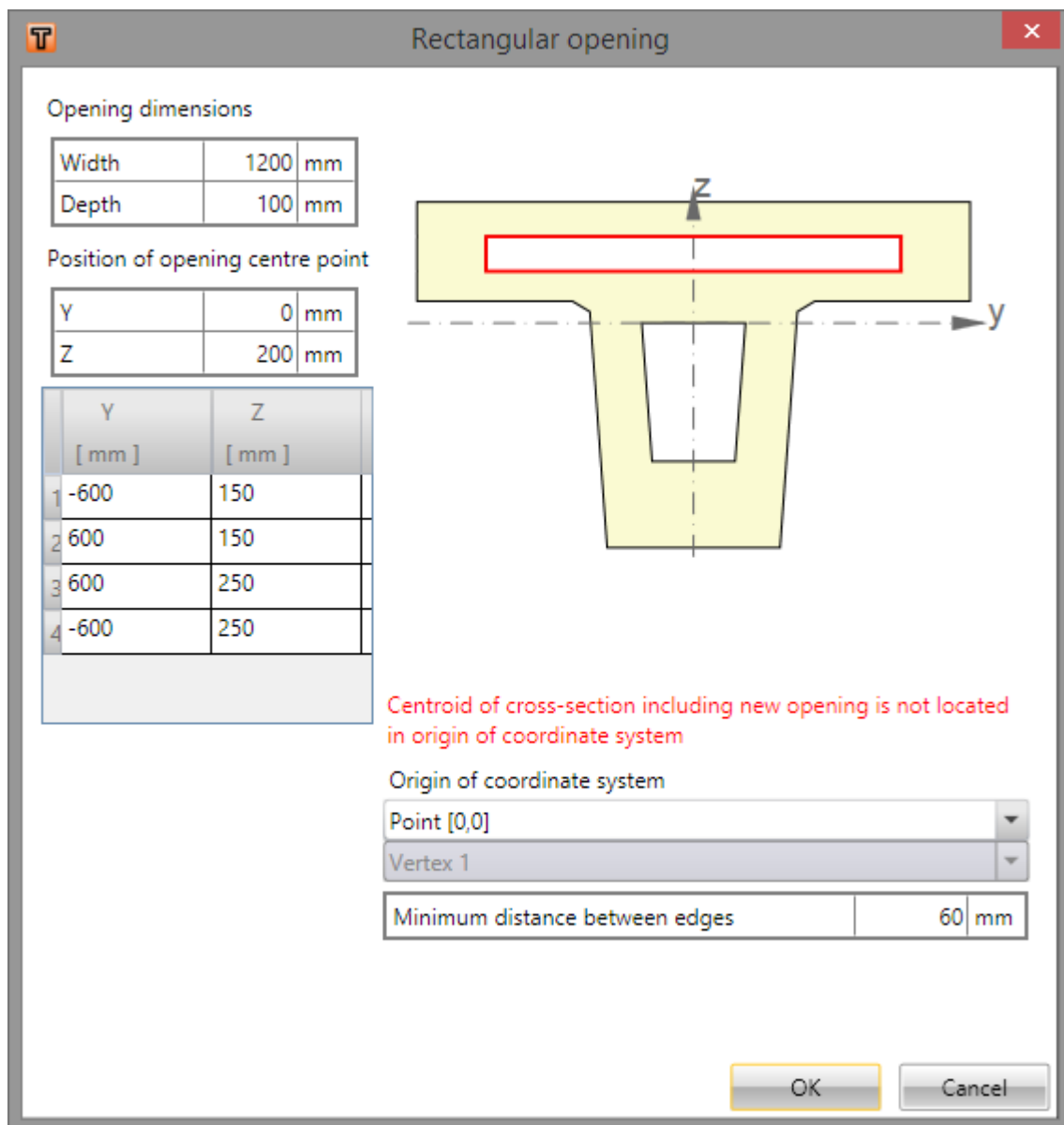

Rectangular opening is defined by width, depth and position of its centre to specified origin point.

- **Origin of coordinate system** – defined vertex coordinates are related to point, which can be selected in the list. Choose from following options:
 - **Point [0,0]** – vertex coordinates are related to origin of cross-section coordinate system
 - **Cross-section vertex** – vertex coordinates are related to vertex, which is selected in list below.
- **Minimum distance between edges** – input minimal allowed distance between edges. If distance between any edges is less than the limit value, it is not possible to insert opening into cross-section.
- **Import** – click to import vertex coordinates from text or .NAV file - see [Format of text files for import and export](#).

8.4.4 New circular opening

To start input of new opening with rectangular shape click **New circle** in ribbon group **Openings**.

T
Circular opening
✕

Opening dimensions

Diameter	100	mm
----------	-----	----

Position of opening centre point

Y	600	mm
Z	200	mm

	Y [mm]	Z [mm]
1	650	200
2	647	217
3	638	232
4	625	243
5	609	249
6	591	249
7	575	243
8	562	232
9	553	217
1	550	200
1	553	183
1	562	168
1	575	157
1	591	151
1	609	151
1	625	157
1	638	168
1	647	183

Centroid of cross-section including new opening is not located in origin of coordinate system

Origin of coordinate system

Point [0,0]

Vertex 1

Minimum distance between edges	60	mm
--------------------------------	----	----

OK

Cancel

Circular opening is defined by diameter and position of its centre to specified origin point.

- **Origin of coordinate system** – defined vertex coordinates are related to point, which can be selected in the list. Choose from following options:

- **Point [0,0]** – vertex coordinates are related to origin of cross-section coordinate system
- **Cross-section vertex** – vertex coordinates are related to vertex, which is selected in list below.
- **Minimum distance between edges** – input minimal allowed distance between edges. If distance between any edges is less than the limit value, it is not possible to insert opening into cross-section.

8.4.5 Shift origin of general cross-section

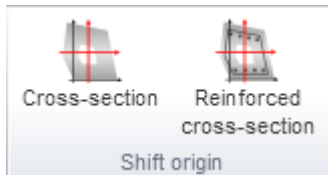

The origin of cross-section [0,0] has to be positioned in the cross-sectional centre of gravity. This is essential due to loading, because the entered load is always applied at the point [0,0] of section.

- **Cross-section** – click to recalculate vertex coordinates of outline and openings such that the origin [0,0] is positioned in the cross-sectional centre of gravity. Reinforcement position is not affected.
- **Reinforced cross-section** – click to recalculate vertex coordinates of outline, openings and positions of reinforcement bars, stirrups and tendons such that the origin [0,0] is positioned in the cross-sectional centre of gravity.

8.5 Dimension line of cross-section shape

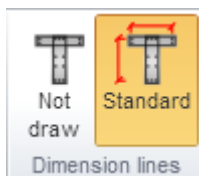

Ribbon group **Dimension lines** can be used to set mode of dimension lines drawing:

- **Not draw** – turns off drawing of dimension lines
- **Standard** – turns on drawing of standard dimension lines of cross-section shape.



8.6 Cross-sectional shape modifications

If IDEA RCS is started from superior application, editing of shape and material properties may not be available.





After clicking on cross-section drawn in the Main window the property dialog is displayed in Data window.

Data

Concrete components of cross-section

Geometry	Material
1 	C30/37 

Openings

Name	Geometry
1 O1 	
2 O2 	

Cross-section characteristics (related to centre of gravity of cross-section)

Type	A [mm ²]	Sy [mm ³]	Sz [mm ³]	Iy [mm ⁴]	Iz [mm ⁴]
Cross-section *)	838662	0	0	69651706948	101563075680
Reinforcement	402	-236812	0	139459634	18532911

Click edit button  in **Geometry** column of table **Concrete components of cross-section** to start modification of cross-section shape.

Material of cross-section can be selected in list **Material**. The list of all the available materials is filtered according to selected Exposure class in the project.



Click edit-button  next to selected material to show or edit the current material characteristics.

Click edit button  in column **Geometry** of table **Openings** to start editing of opening shape. To delete selected opening click **Delete** in ribbon group **Openings**.

8.6.1 Composite cross-section modification

Data

Composite cross-section

Geometry	Material 1	Material 2
	C30/37 	C30/37 

Joints

Name	Type	Self weight
1 J1	Rough 	<input type="checkbox"/>

Materials for individual cross-section components can be defined for the composite cross-section.

The joints parameters can be defined in the table **Joints**:

- **Type** – select the roughness of the surfaces in the joint.
- **Self-weight** – switch on/off taking into account the self-weight of cross-section component above the joint during the joint check.

9 Prestressing reinforcement

For the current section (set in list **Current section** in top of Navigator), click navigator command **Current Section & Extreme > Prestressing** to input tendons and tendon ducts into the cross-section.

Ribbon groups **Tendons**, **tendon ducts**, **Import-Export**, **View settings**, **Dimension lines** and **Calculation** are available. Depending on member type or shape of cross-section some of ribbon groups may not be available.

If IDEA RCS is started from superior application, some items for input and editing of prestressed reinforcement may not be available.

Input of prestressing reinforcement is performed in **Reinforcement editor** module.

The existing prestressing reinforcement can be modified either in **Reinforcement editor** or in tables in the Data window.

9.1 Prestressing reinforcement editor

To launch prestressing reinforcement editor click **Reinforcement editor** command in ribbon group **Tendons, tendon ducts** in navigator command **Current Section & Extreme > Prestressing**.

Current reinforced section is displayed in the main window of reinforcement editor.

Following tabs are displayed in the data window of reinforcement editor:

- table of prestressing tendon properties is displayed on tab **Tendons**.
- table of tendon ducts properties is displayed on tab **Ducts**.

Ribbon groups **Tendons, ducts and tubes** and **Labelling, dimension lines** are available.

The diagram shows a vertical reinforced section with a width of 1465 mm and a height of 9540 mm. It features a central tendon and two reinforcement bars labeled '2x100'. A coordinate system with x, y, and z axes is shown at the bottom left.

The software interface below the diagram shows the 'Data' window with the 'Tendons' tab selected. It includes a table of tendon properties and a panel for layer and bar details.

Layer	As [mm ²]	Type of prestressing	np	α_{XZ} [°]	α_{XY} [°]	Material
> 1	700	Post-tensioned	1	0,0	0,0	Y1770S7-12.9
2	700	Post-tensioned	1	0,0	0,0	Y1770S7-12.9

Layer details

- n: 1
- n s: 7

Linked tendon duct layer

- Duct layer: 1
- Ø [mm]: 55
- Material: Metal

Bar position

- Origin: Point (0,0)
- Y [mm]: 0
- Z [mm]: -698

9.1.1 Tendons

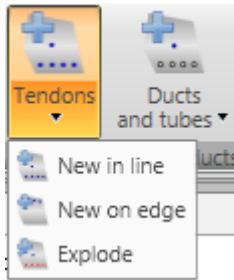

Drop-down button **Tendons** in ribbon group **Tendons, ducts and tubes** collects commands for tendons operations:

- **New in line** – adds a new layer of tendons defined by coordinates of first and last tendon in layer.
- **New on edge** – adds a new layer of tendons related to cross-section edge.
- **Explode** – explodes layer of tendons to separate tendons with editable coordinates.

Tendons are defined by layers. A layer is defined by the number of tendons in the layer and position. Position can be specified by:

- coordinates of the first tendon in the layer, and the coordinates of the last tendon in the layer,
- edge, to which the layer is related and offsets of tendons layer from the edge.

Number of strands, type of prestressing, order of prestressing, slope angle, duct diameter, material of prestressing reinforcement and material of tendon duct can be assigned to individual layers.

List of defined tendon layers is displayed in the table **Tendons** on the **Tendons tab** in the data window. For the selected tendon layer a table of properties is displayed.

Columns in **Tendons table**:

- **As** – calculated value of tendons area in layer is displayed
- **Type of prestressing** – select type of tendon prestressing procedure:
 - **Post-tensioned** – tendon is assumed to be post-tensioned. Duct (with diameter specified in column \varnothing duct) is generated for post-tensioned tendon.
 - **Pre-tensioned** - tendon is assumed to be pre-tensioned and duct is not generated.
- **np** – input order of prestressing. The entered number corresponds to the order of time node, in which is the prestressing applied, on the global time axis (it means that the first time node, in which is the prestressing applied, is nr. 1, the second time node, in which is the prestressing applied, is nr. 2 etc.).
- **α XZ** – input value of tendon slope to centre line in XZ-plane.
- **α XY** – input value of tendon slope to centre line in XY-plane.
- **Material** – in the list of available materials select material of tendons in layer or click edit button to edit material properties.
-  - delete tendons layer from table including the eventual corresponding layer of tendon ducts.

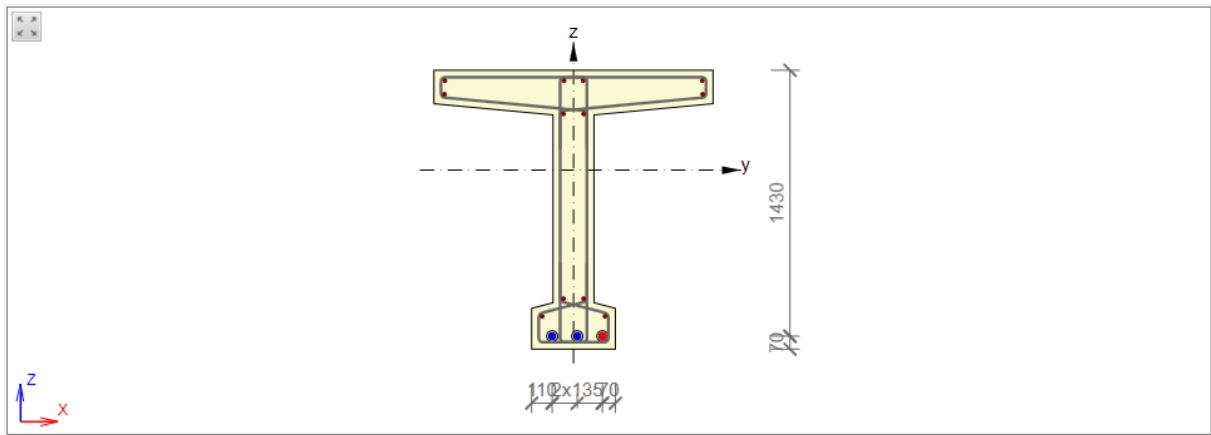

Data

Tendons Ducts

Tendons

Layer	As [mm ²]	Type of prestressing	np	α_{XZ} [°]	α_{XY} [°]	Material
2	900	Post-tensioned	1	0,0	0,0	Y1860S7-15.7
3	900	Post-tensioned	1	0,0	0,0	Y1860S7-15.7
>	4	Post-tensioned	1	0,0	0,0	Y1860S7-15.7

Layer details

n

n s

Linked tendon duct layer

Duct layer

Ø [mm]

Material

Bar position

Origin

Y [mm]

Z [mm]

9.1.1.1 Layer of tendons defined by coordinates

To input layer of tendons defined by coordinates of first and last tendon in layer click **Tendons > New in line** in ribbon group **Tendons, ducts and tubes** or click **New in line** above the **Tendons** table.

Layer details	
n	2
n s	6
Linked tendon duct layer	
Duct layer	2
Ø [mm]	60
Material	Metal
First point	
Origin	vertex 1
Δ Y [mm]	50
Δ Z [mm]	50
Y [mm]	-700
Z [mm]	587
Last point	
Origin	vertex 2
Δ Y [mm]	-50
Δ Z [mm]	50
Y [mm]	-800
Z [mm]	407

Properties of tendons layer defined by coordinates:

Properties group **Layer details**:

- **n** – input number of tendons in layer.
- **ns** – input number of strands in tendon.

Properties group **Linked tendon duct layer**:

- **Duct layer** – number of tendon duct layer, which is linked to the current tendon layer, is displayed.
- **Ø** – input diameter of tendon duct. Minimal value of diameter is determined according to number of strands in tendon.
- **Material** – select material of tendon duct.

Properties group **First point**:

- **Origin** – select origin, to which coordinates of first tendon in layer are related. Position of tendon can be related to point [0;0] (center of gravity) or to selected cross-section vertex.
- **ΔY**,
- **ΔZ** – input distance of first tendon in layer to the selected origin in direction of the corresponding axis.

- **Y**,
- **Z** – coordinates of first tendon in layer to the center of gravity in direction of the corresponding axis are displayed.

Properties group **Last point**:

- **Origin** – select origin, to which coordinates of last tendon in layer are related. Position of tendon can be related to point [0;0] (center of gravity) or to selected cross-section vertex.
- **ΔY** ,
- **ΔZ** – input distance of last tendon in layer to the selected origin in direction of the corresponding axis.
- **Y**,
- **Z** – coordinates of last tendon in layer to the center of gravity in direction of the corresponding axis are displayed.

9.1.1.2 Layer of tendons on edge

To input layer of tendons at cross-section edge click **Tendons > New on edge** in ribbon group **Tendons, ducts and tubes** or click **New on edge** above the **Tendons** table.

Layer details	
n	3
n s	1
Edge	6
Edge cover [mm]	20
Left cover [mm]	20
Right cover [mm]	20
Linked tendon duct layer	
Duct layer	3
Ø [mm]	60
Material	Metal

Properties of tendons layer on edge:

Properties group **Layer details**:

- **n** – input number of tendons in layer.
- **ns** – input number of strands in tendon.
- **Edge** – select edge, to which layer of tendons is related.
- **Edge cover** – input value of cover to the selected cross-section edge.
- **Left cover** – input value of cover between the most left tendon in layer and left edge of cross-section.
- **Right cover** – input value of cover between the most right tendon in layer and right edge of cross-section.

Properties group **Linked tendon duct layer**:

- **Duct layer** – number of tendon duct layer, which is linked to the current tendon layer, is displayed.
- **Ø** – input diameter of tendon duct. Minimal value of diameter is determined according to number of strands in tendon.
- **Material** – select material of tendon duct.

9.1.1.3 Exploding tendon layer

To explode selected tendons layer to single tendons click **Tendons > Explode** in ribbon group **Tendons, ducts and tubes**. Exploded tendons can be edited separately.

9.1.2 Tendon ducts

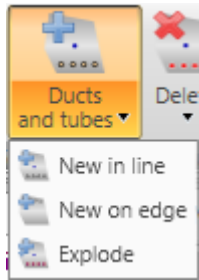

Drop-down button **Ducts and tubes** in ribbon group **Tendons, ducts and tubes** collects commands for tendon ducts operations:

- **New in line** – adds a new layer of tendon ducts defined by coordinates of first and last tendon duct in layer.
- **New on edge** – adds a new layer of tendon ducts related to cross-section edge.
- **Explode** – explodes layer of tendon ducts to separate ducts with editable coordinates.

Tendon ducts are defined by layers. A layer is defined by the number of ducts in the layer and position. Position can be specified by:

- coordinates of the first duct in the layer, and the coordinates of the last duct in the layer,
- edge, to which the layer is related and offsets of ducts layer from the edge.

Duct diameter can be assigned to individual layers.

List of defined tendon ducts is displayed in the table **Tendon ducts** on the **Ducts** tab in the data window. For the selected duct a table of duct properties is displayed.

Columns in **Tendon ducts** table:

- **Layer** – index of ducts layer is displayed.
- \emptyset – input tendon duct diameter.
- **As** – area of ducts in layer is displayed.
-  - delete ducts layer from table including the eventual corresponding layer of tendons.

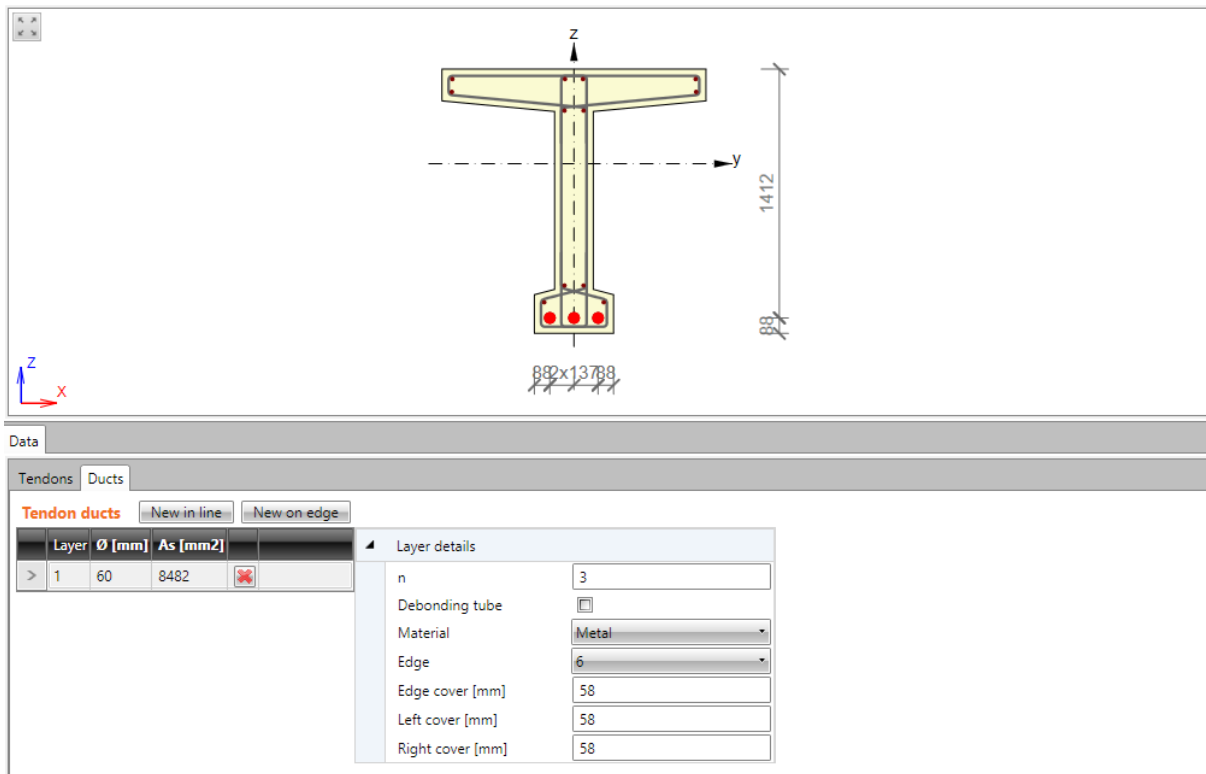

Data

Tendon ducts Ducts

Tendon ducts New in line New on edge

Layer	Ø [mm]	As [mm ²]	
> 1	60	8482	

Layer details

- n: 3
- Debonding tube:
- Material: Metal
- Edge: 6
- Edge cover [mm]: 58
- Left cover [mm]: 58
- Right cover [mm]: 58

9.1.2.1 Layer of tendon ducts defined by coordinates

To input layer of tendon ducts defined by coordinates of first and last duct in layer click **Ducts, tubes > New** in line in ribbon group **Tendons, ducts and tubes** or click **New in line** above the **Tendon ducts** table.

Layer details	
n	2
Debonding tube	<input type="checkbox"/>
Material	Metal
First point	
Origin	vertex 6
ΔY [mm]	60
ΔZ [mm]	60
Y [mm]	-165
Z [mm]	-903
Last point	
Origin	vertex 7
ΔY [mm]	-60
ΔZ [mm]	60
Y [mm]	165
Z [mm]	-903

Properties of ducts layer defined by coordinates:

Properties group **Layer details**:

- **n** – input number of ducts in layer.
- **Debonding tube** – if selected, the debonding tube is defined, otherwise tendon duct is defined.
- **Material** – select material of tendon duct.

Properties group **First point**:

- **Origin** – select origin, to which coordinates of first duct in layer are related. Position of duct can be related to point [0;0] (center of gravity) or to selected cross-section vertex.
- **ΔY** ,
- **ΔZ** – input distance of first duct in layer to the selected origin in direction of the corresponding axis.
- **Y**,
- **Z** – coordinates of first duct in layer to the center of gravity in direction of the corresponding axis are displayed.

Properties group **Last point**:

- **Origin** – select origin, to which coordinates of last duct in layer are related. Position of duct can be related to point [0;0] (center of gravity) or to selected cross-section vertex.
- **ΔY** ,

- ΔZ – input distance of last duct in layer to the selected origin in direction of the corresponding axis.
- Y ,
- Z – coordinates of last duct in layer to the center of gravity in direction of the corresponding axis are displayed.

9.1.2.2 Layer of tendon ducts on edge

To input layer of tendon ducts along the cross-section edge click **Ducts, tubes > New on edge** in ribbon group **Tendons, ducts and tubes** or click **New on edge** above the **Tendon ducts** table.

Layer details	
n	3
Debonding tube	<input type="checkbox"/>
Material	Metal
Edge	6
Edge cover [mm]	50
Left cover [mm]	50
Right cover [mm]	50

Properties of tendon ducts layer on edge:

Properties group **Layer details**:

- **n** – input number of tendons in layer.
- **Debonding tube** – if selected, the debonding tube is defined, otherwise tendon duct is defined.
- **Material** – select material of tendon duct.
- **Edge** – select edge, to which layer of tendon ducts is related.
- **Edge cover** – input value of cover to the selected cross-section edge.
- **Left cover** – input value of cover between the most left duct in layer and left edge of cross-section.
- **Right cover** – input value of cover between the most right duct in layer and right edge of cross-section.

9.1.2.3 Exploding tendon ducts layer

To explode selected tendon ducts layer to single ducts click **Ducts and tubes > Explode** in ribbon group **Tendons, ducts and tubes**. Exploded ducts can be edited separately.

9.1.3 Deleting prestressing reinforcement

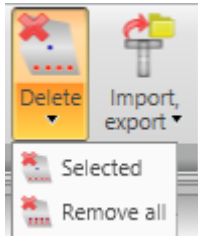

Use commands in group **Delete** in ribbon group **Tendons, ducts and tubes** to delete prestressing reinforcement or tendon duct:

- **Selected** - delete selected tendon, tendon layer, tendon duct or layer of tendon ducts.
- **All** – delete all tendons and tendon ducts.

9.1.4 Import and export of prestressing reinforcement

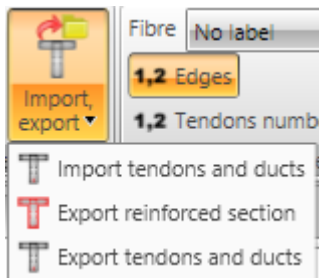

Drop-down button **Import, export** in ribbon group **Tendons, ducts and tubes** collects commands for import and export of prestressing reinforcement:

- **Import tendons and ducts** - start import of prestressing reinforcement from text file.
- **Export reinforced section** – start export of cross-section shape and reinforcement to the text file in *.NAV format.
- **Export tendons and ducts** – start export of prestressing reinforcement to the text file in *.NAV format.

9.1.5 View settings of reinforced cross-section

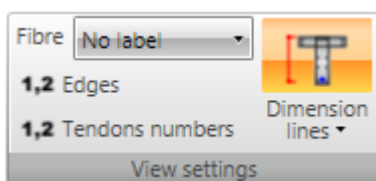

Drawing options can be set in ribbon group **View settings**:

- **Fibre** – select mode of fibres drawing in the list:
 - **No labels** – description of fibres is not drawn.
 - **Outside** – fibre numbers are drawn outside the cross-section outline.
 - **Inside** – fibre numbers are drawn inside the cross-section outline.
- **Edges** – switch on/off drawing of numbers of edges.
- **Tendon numbers** – switch on/off drawing of tendon numbers.

- **Dimension lines** – switch on/off drawing of dimension lines:
 - **Standard** – switch to drawing of standard dimension lines of reinforcement.
 - **Stationing** – switch to drawing of dimension lines with distances related to reference point.

9.2 Editing tendons

Tendons defined using Reinforcement editor can be modified in tables in the Data window.

Properties of tendon selected by mouse in the Main window are displayed in a table in Data window.

Data																				
Single tendons																				
Layer	A_s [mm ²]	Type of prestressing	n_p	α_{XZ} [°]	α_{XY} [°]	Material	First point Origin	distance Y [mm]	distance Z [mm]	Y [mm]	Z [mm]									
1	100	Pre-tensioned	1	0,0	0,0	Y1770S7-12.9	Point (0,0)	0	-450	0	-450									
Single tendons and linked tendon duct																				
Layer	n_s	\emptyset duct [mm]	A_s [mm ²]	Type of prestressing	n_p	α_{XZ} [°]	α_{XY} [°]	Material	Duct material	First point Origin	distance Y [mm]	distance Z [mm]	Y [mm]	Z [mm]						
2	1	13	100	Post-tensioned	1	0,0	0,0	Y1770S7-12.9	Metal	Point (0,0)	0	-300	0	-300						
Tendon layer with uniform distance in line																				
Layer	n	A_s [mm ²]	Type of prestressing	n_p	α_{XZ} [°]	α_{XY} [°]	Material	First point Origin	distance Y [mm]	distance Z [mm]	Y [mm]	Z [mm]	Last point Origin	distance Y [mm]	distance Z [mm]	Y [mm]	Z [mm]			
1	2	200	Pre-tensioned	1	0,0	0,0	Y1770S7-12.9	vertex 4	50	50	-50	-883	vertex 5	-50	50	50	-883			
Tendon layer and linked tendon duct layer with uniform distance in line																				
Layer	n_s	n	\emptyset duct [mm]	A_s [mm ²]	Type of prestressing	n_p	α_{XZ} [°]	α_{XY} [°]	Material	Duct material	First point Origin	distance Y [mm]	distance Z [mm]	Y [mm]	Z [mm]	Last point Origin	distance Y [mm]	distance Z [mm]	Y [mm]	Z [mm]
2	1	2	13	200	Post-tensioned	1	0,0	0,0	Y1770S7-12.9	Metal	vertex 4	50	50	-50	-883	vertex 5	-50	50	50	-883
Tendon layer with uniform distance on cross-section edge																				
Layer	n	A_s [mm ²]	Type of prestressing	n_p	α_{XZ} [°]	α_{XY} [°]	Material	Edge	Edge cover [mm]	Left cover [mm]	Right cover [mm]									
1	2	200	Pre-tensioned	1	0,0	0,0	Y1770S7-12.9	4	38	38	38									
Tendon layer and linked tendon duct layer with uniform distance on cross-section edge																				
Layer	n_s	n	\emptyset duct [mm]	A_s [mm ²]	Type of prestressing	n_p	α_{XZ} [°]	α_{XY} [°]	Material	Duct material	Edge	Edge cover [mm]	Left cover [mm]	Right cover [mm]						
2	1	2	36	200	Post-tensioned	1	0,0	0,0	Y1770S7-12.9	Metal	4	48	48	48						

According to input type of selected tendon following tendon properties can be edited:

- For single pre-tensioned tendons in table **Single tendons** can be edited: order of prestressing, slopes in two directions, tendon material characteristics and position related to origin
- For single post-tensioned tendons in table **Single tendons and linked tendon ducts** can be edited: number of strands in tendon, tendon duct diameter, tendon duct material, order of prestressing, slopes in two directions, tendon material characteristics and position related to origin
- For layer of pre-tensioned tendons defined by coordinates in table **Tendon layer with uniform distance in line** can be edited: number of tendons in layer, order of prestressing, slopes in two directions, tendon material characteristics, positions of first and last tendon in layer related to origin.
- For layer of post-tensioned tendons defined by coordinates in table **Tendon layer and linked tendon duct layer with uniform distance in line** can be edited: number of tendons in layer, number of strands in tendon, tendon duct diameter, duct material, order of prestressing, slopes in two directions, tendon material characteristics, positions of first tendon in layer and last tendon in layer related to origin.
- For layer of pre-tensioned tendons defined at cross-section edge in table **Tendon layer with uniform distance on cross-section edge** can be edited: number of tendons in layer, order of prestressing, slopes in two directions, tendon material characteristics, edge cover, left cover, right cover.
- For layer of post-tensioned tendons defined at cross-section edge in table **Tendon layer and linked tendon duct layer with uniform distance on cross-section edge** can be edited: number of tendons in layer, number of strands in tendon, tendon duct diameter, duct material, order of prestressing, slopes in two directions, material characteristics, edge cover, left cover, right cover.

9.3 Editing tendon ducts and debonding tubes

Tendon ducts and debonding tubes defined in Reinforcement editor can be edited in tables in Data window. Properties tendon duct/debonding tube of selected by mouse in the main window are displayed in a table in Data window.

Single tendon ducts

Layer	∅ [mm]	As [mm ²]	Duct material	First point Origin	distance Y [mm]	distance Z [mm]	Y [mm]	Z [mm]
1	20	314	Metal	Point (0,0)	0	-350	0	-350

Tendon duct layer with uniform distance in line

Layer	n	∅ [mm]	As [mm ²]	Duct material	First point Origin	distance Y [mm]	distance Z [mm]	Y [mm]	Z [mm]	Last point Origin	distance Y [mm]	distance Z [mm]	Y [mm]	Z [mm]
2	2	20	628	Metal	vertex 4	50	50	-50	-883	vertex 5	-50	50	50	-883

Tendon duct layer with uniform distance on cross-section edge

Layer	n	∅ [mm]	As [mm ²]	Duct material	Edge	Edge cover [mm]	Left cover [mm]	Right cover [mm]
3	2	20	628	Metal	4	38	38	38

Single debonding tubes

Layer	∅ [mm]	As [mm ²]	First point Origin	distance Y [mm]	distance Z [mm]	Y [mm]	Z [mm]
1	20	314	Point (0,0)	0	-350	0	-350

Debonding tube layer with uniform distance in line

Layer	n	∅ [mm]	As [mm ²]	First point Origin	distance Y [mm]	distance Z [mm]	Y [mm]	Z [mm]	Last point Origin	distance Y [mm]	distance Z [mm]	Y [mm]	Z [mm]
2	2	20	628	vertex 4	50	50	-50	-883	vertex 5	-50	50	50	-883

Debonding tube layer with uniform distance on cross-section edge

Layer	n	∅ [mm]	As [mm ²]	Edge	Edge cover [mm]	Left cover [mm]	Right cover [mm]
3	2	20	628	4	38	38	38

According to input type of selected tendon duct/debonding tube following tendon duct/debonding tube properties can be edited:

- For single tendon ducts/debonding tube diameter of duct, material of duct and position related to origin can be edited in table **Single tendon duct/Single debonding tube**.
- For tendon duct layer defined by coordinates number of tendon ducts in layer, ducts diameter, duct material, positions of first and last duct in layer related to origin can be edited in table **Tendon duct layer with uniform distance in line/ Debonding tube layer with uniform distance in line**.
- For tendon duct layer defined at cross-section edge number of tendon ducts in layer, ducts diameter, duct material, edge cover, left cover, right cover can be edited in table **Tendon duct layer with uniform distance on cross-section edge/ Debonding tube layer with uniform distance on cross-section edge**.

9.4 Deleting prestressing reinforcement

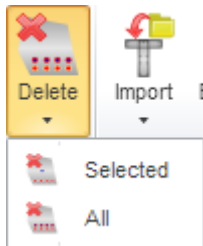

Use commands in ribbon group **Delete** to delete prestressing reinforcement or tendon duct.

- **Selected** - delete selected tendon, tendon layer, tendon duct or layer of tendon ducts.
- **All** – delete all tendons and tendon ducts.

9.5 View settings of reinforced cross-section

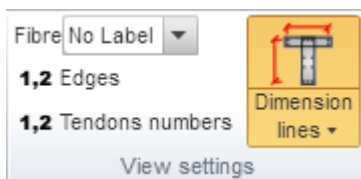

Drawing options can be set in ribbon group **View settings**:

- **Fibre** – select mode of fibres drawing in the list:
 - **No labels** – description of fibres is not drawn.
 - **Outside** – fibre numbers are drawn outside the cross-section outline.
 - **Inside** – fibre numbers are drawn inside the cross-section outline.
- **Edges** – switch on/off drawing of numbers of edges.
- **Tendon numbers** – switch on/off drawing of tendon numbers.
- **Dimension lines** – switch on/off drawing of dimension lines:
 - **Standard** – switch to drawing of standard dimension lines of reinforcement.
 - **Stationing** – switch to drawing of dimension lines with distances related to reference point.

10 Construction and action stages

10.1 Construction stages

If IDEA RCS is started from superior application, construction stages may be set to read only.

The time axis of staged section of current design member can be modified on the tab **Construction stages** in navigator **Current Section & Extreme > Design member**. Particular nodes on time axis and their properties are present in a table in Main window. The time nodes, when the prestressing is applied or when the cross-section component is cast, can be defined.

Ribbon groups **Time axis points**, **Time axis label** and **Cross-section** are available.

Columns of table:

- **Name** – name of the node on the time axis.
- **Age** – number of days since casting.
- **Phase** – if the option is selected, a cross-section component in the time node, which has the same number as the number at the checkbox. The order of casting corresponds to the time-order of time nodes. Thus the first time node, in which the cross-section component is cast, has the phase number 1, the second time node, in which the cross-section component is cast, has the phase number 2 etc.
- **Age** – input the equivalent age of concrete, e.g. to take into account the elevated temperature on the maturity of concrete.
- **Prestressing** – if the checkbox is checked, it means that in this node of time axis the prestressing is introduced into the cross-section. The prestressing is applied from tendons, which have set the appropriate order of prestressing. The order of prestressing corresponds to the time-order of time nodes, in which the prestressing is applied. Thus the first time node, in which the prestressing is applied, corresponds with the order of prestressing 1, the second time node, in which prestressing is applied, corresponds with the order of prestressing 2 etc.
- **Description** - a comment to time axis point.
- **Add** – add new point on time axis.
- **Delete** – delete selected point from time axis.

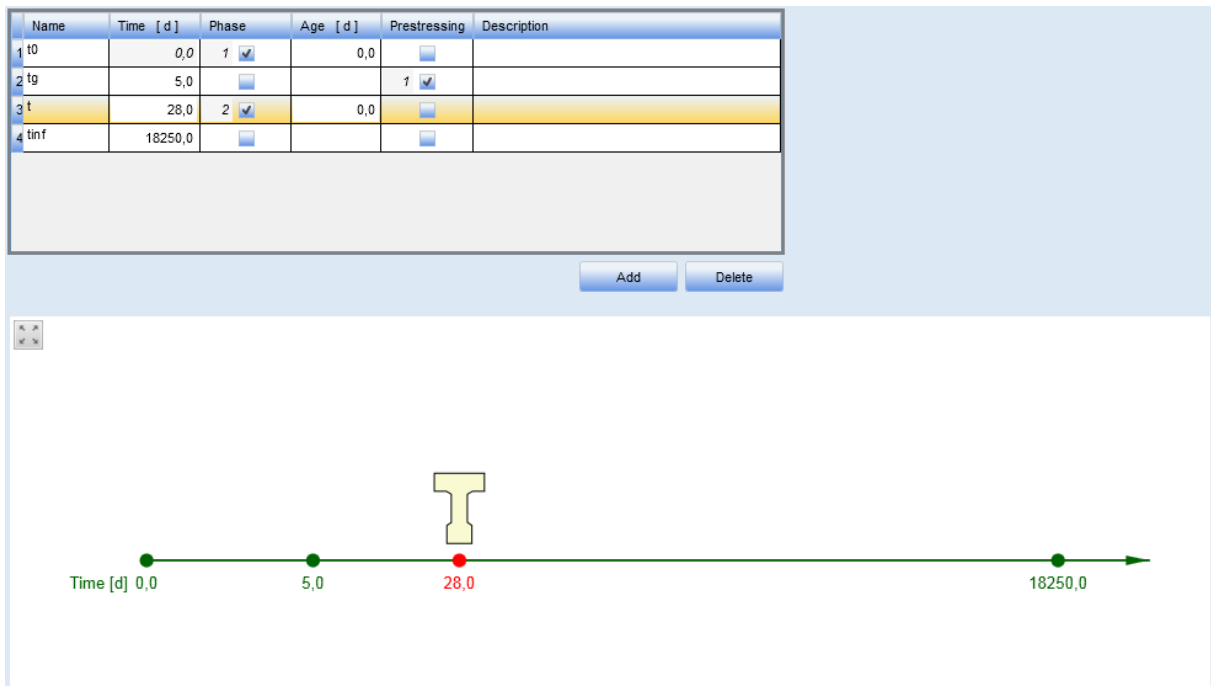

10.1.1 Ribbon group Time axis points

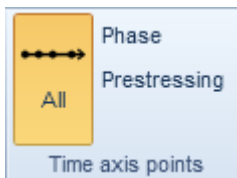

Commands in ribbon group **Time axis points**:

- **All** – switch to draw all points of the time axis.
- **Phase** – switch to draw only the points, in which the cross-section component is cast.
- **Prestressing** – switch to draw only the points, in which the prestressing is applied.

10.1.2 Ribbon group Time axis label

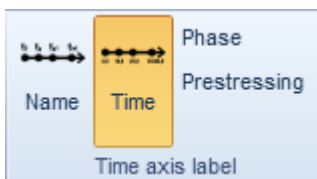

Commands in ribbon group **Time axis label**:

- **Name** – switch on/off drawing of name of the time axis points.
- **Time** – switch on/off drawing of the time of the time axis points.
- **Phase** – switch on/off drawing of cross-section component number at the corresponding time axis points.
- **Prestressing** – switch on/off drawing of cross-section component number at the corresponding time axis points.

10.1.3 Ribbon group Cross-section

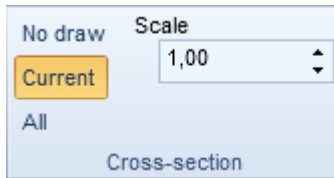

Commands in ribbon group **Cross-section**:

- **Not draw** – switch off the drawing of cross-section components for all time axis points.
- **Current** – switch to draw the existing cross-section components for the current time axis point. The cross-section component age must be greater than three days to be able to check it at the time of the time-axis node.
- **All** – switch to draw all existing cross-section components in all nodes of the time-axis.
- **Scale** – set the drawing scale of the cross-sections.

10.2 Action stages

If IDEA RCS is started from superior application, construction stages may be set to read only.

Click navigator command **Current Section & Extreme > Action stages** to edit increments of load in particular nodes of the time axis. Particular nodes of the time axis and their properties are displayed in a table in Main window.

Ribbon group **Recalculation of losses** is available.

According to selected type of prestressing primary effect of prestressing are calculated and values of secondary effects of prestressing can be defined

Determination of initial state of cross-section

Increments of effects of characteristic permanent load (used for calculation of prestressing losses, ULS and SLS checks)

Time [d]	N [kN]	Vy [kN]	Vz [kN]	T [kNm]	My [kNm]	Mz [kNm]
5,0	0,00	0,00	0,00	0,00	0,00	0,00
28,0	0,00	0,00	0,00	0,00	0,00	0,00
18250,0	0,00	0,00	0,00	0,00	0,00	0,00

Prestressing

Type of prestressing input

Tendon	Time [d]	σ_{pm0} [MPa]	$\Delta\sigma_{pr}$, occurred [MPa]
1	5,0	1394,00	-10,00
2	5,0	1394,00	-10,00

Total effect of prestressing caused by tensioned tendons

Time [d]	Effect of prestressing	N [kN]	Vy [kN]	Vz [kN]	T [kNm]	My [kNm]	Mz [kNm]
5,0	Primary	-2509,20	0,00	0,00	0,00	-1198,79	0,00
	Secondary	0,00	0,00	0,00	0,00	0,00	0,00

Determination of initial state of cross-section – select the mode of determination of initial state of cross-section. If **User input/Import** is set and the type of prestressing input is set to **Stress after long-term losses** or **Estimation of prestressing losses**, the tables to define user values of initial cross-section state are displayed.

Table Increments of effects of characteristics permanent load

Values of load increments for particular points of time axis are specified in particular table rows. Those loads can be transferred into load effect for check in particular time.

Type of prestressing – select type of losses calculation and determination of primary effects of prestressing. Following modes of prestressing input can be chosen:

- **Estimation of prestressing losses** – for each tendon in the appropriate time of prestressing the value of maximal stress in tendon is displayed in the table below the list. Coefficient for determination of short-term and long-term losses can be specified.
- **Stress after short-term losses** – in the table below for each tendon in the appropriate time of prestressing the value of calculated stress in prestressing reinforcement just after introduction of prestressing and the value of relaxation occurred in the past is displayed. Table with results of long-term losses is displayed in Data window.
- **Stress after long-term losses** – in the table below for each tendon and the appropriate time of prestressing the stress in tendon after long-term losses can be specified.

Table Total effect of prestressing

Calculated values of primary effects of prestressing in cross-section are displayed in the table. User defined values of secondary effects of prestressing can be entered into row **Secondary effects of prestressing**.

10.2.1 Effect in cross-section components

If mode **User input/Import** of determination of initial state of cross-section is set, the tables to define user values of initial cross-section state are displayed.

Effects in cross-section components

Type of effects

Time [d]	Component	N [kN]	Vy [kN]	Vz [kN]	T [kNm]	My [kNm]	Mz [kNm]
0,0	1	0,00	0,00	0,00	0,00	0,00	0,00
5,0	1	0,00	0,00	0,00	0,00	0,00	0,00
28,0	1	0,00	0,00	0,00	0,00	0,00	0,00
	2	0,00	0,00	0,00	0,00	0,00	0,00
18250,0	1	0,00	0,00	0,00	0,00	0,00	0,00
	2	0,00	0,00	0,00	0,00	0,00	0,00

Stress in reinforcement bars

Determination of initial effects

Bar	σ_s 0,0 [MPa]	σ_s 5,0 [MPa]	σ_s 28,0 [MPa]	σ_s 18250,0 [MPa]
1	0,00	0,00	0,00	0,00
2	0,00	0,00	0,00	0,00
3	0,00	0,00	0,00	0,00
4	0,00	0,00	0,00	0,00
5	0,00	0,00	0,00	0,00
6	0,00	0,00	0,00	0,00

According to the selected type of effect either internal forces or deformation plane can be defined for individual cross-section part at the times of the time axis.

If the **Determination of initial effects** is set to **User input/Import** in the **Stress in reinforcement bars** table, the initial stress can be defined for each reinforcement bar at each time of the time axis.

10.2.2 Ribbon group Recalculation of losses

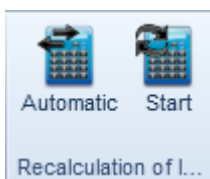

- **Automatic** – if the option is selected, the stresses after long term losses are recalculated automatically after each change in the tables of action stages.
- **Start** – calculate the stresses after long term losses for the currently defined values.

10.2.3 Ribbon group Resultant of stage

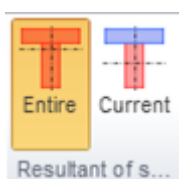

- **Entire** - internal forces will be related to the centroid of concrete cross-section (without the reinforcement) with modulus of elasticity at the age 28 days. All phases of cross-section are taken into account in the case of composite cross-section irrespective of the fact if they currently exist..
- **Current** - internal forces will be related to the centroid of transformed cross-section determined from currently existing phases of cross-section and their prestressing reinforcement. Change of modulus of elasticity due to concrete aging is considered in all phases of cross-section.

11 Load effects input

For the current section and current loads extreme (set in lists **Current section** and **Current extreme** in top of Navigator), click navigator command **Current Section & Extreme > Internal forces** to launch the input-dialog of sectional internal forces. The forces are input by the user into particular Load Combination types. The combinations may be of various types. Each type of combination is used for different checks:

- **Fundamental ULS** – values of internal forces defined in this combination type are used to perform ultimate limit states checks and detailing check.
- **Accidental** - values of internal forces defined in this combination type are used to perform ultimate limit states checks.
- **Max. cyclic loads** – the combination for fatigue check to calculate the maximal stress range.
- **Min. cyclic loads** - the combination for fatigue check to calculate the minimal stress range.
- **Characteristic load combination** – values of internal forces defined in this combination type are used to perform stress limitation check.
- **Quasi permanent load combination** – values of internal forces defined in this combination type are used to perform stress limitation check, crack widths check, stiffness check and flexural slenderness check.

If the checkbox in column **Use** is not on, the appropriate combination is considered as not defined. Thus the checks, which require this combination, are not performed.

11.1 1D section internal forces

If IDEA RCS is started from superior application, forces for 1D design members may be set to read only.

The entered forces are always related to [0, 0] point of the section.

Combination type	Use	N [kN]	Vy [kN]	Vz [kN]	T [kNm]	My [kNm]	Mz [kNm]
Fundamental ULS	<input checked="" type="checkbox"/>	0,0	0,0	0,0	0,0	214,9	0,0
Accidental	<input type="checkbox"/>	0,0	0,0	0,0	0,0	0,0	0,0
Max. cyclic load	<input checked="" type="checkbox"/>	0,0	0,0	0,0	0,0	0,0	0,0
Min. cyclic load	<input checked="" type="checkbox"/>	0,0	0,0	0,0	0,0	0,0	0,0
Characteristic	<input checked="" type="checkbox"/>	0,0	0,0	0,0	0,0	0,0	0,0
Quasi-permanent	<input checked="" type="checkbox"/>	0,0	0,0	0,0	0,0	0,0	0,0

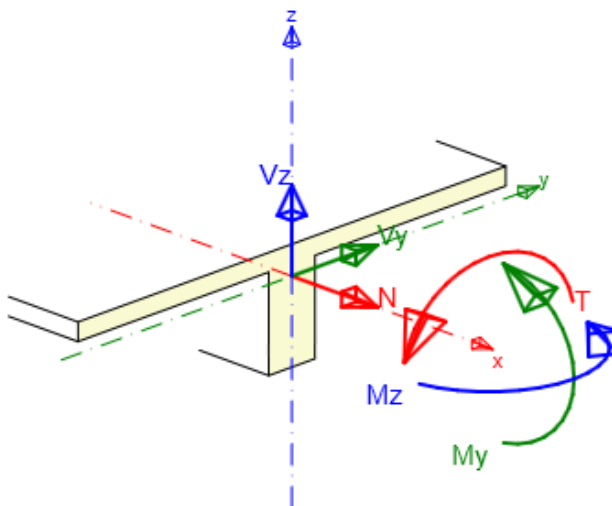

11.2 2D Section internal forces

If IDEA RCS is started from superior application, forces for 2D design members may be set to read only.

For 2D member sections the load effects are defined in the centroidal plane. By default, the checks are performed in the direction of the principal stresses calculated from the entered internal forces. In the table below the load effects input table, it is possible to define different directions for the performed checks.

Ribbon group **Recalculation of design forces** is available when entering internal forces for 2D members.

The internal forces components are filtered according to the selected design member type:

Combination type	Use	m_x [kNm/m]	m_y [kNm/m]	m_{xy} [kNm/m]	n_x [kN/m]	n_y [kN/m]	n_{xy} [kN/m]	q_x [kN/m]	q_y [kN/m]
Fundamental ULS	<input checked="" type="checkbox"/>	171,4	1165,9	0,0	-1704,5	-1785,7	0,0	-0,9	39,4
Accidental	<input type="checkbox"/>	0,0	0,0	0,0	0,0	0,0	0,0	0,0	0,0
Max. cyclic load	<input checked="" type="checkbox"/>	0,0	0,0	0,0	0,0	0,0	0,0	0,0	0,0
Min. cyclic load	<input checked="" type="checkbox"/>	0,0	0,0	0,0	0,0	0,0	0,0	0,0	0,0
Characteristic	<input checked="" type="checkbox"/>	0,0	0,0	0,0	0,0	0,0	0,0	0,0	0,0
Quasi-permanent	<input checked="" type="checkbox"/>	171,4	1165,9	0,0	-1704,5	-1785,7	0,0	0,0	0,0

Combination type	Checked direction	Angle from x-axis [°]
Fundamental ULS	Principal stress direction	0,0
Accidental	User direction	0,0
Max. cyclic load	User direction	0,0
Min. cyclic load	User direction	0,0
Characteristic	Principal stress direction	0,0
Quasi-permanent	Principal stress direction	0,0

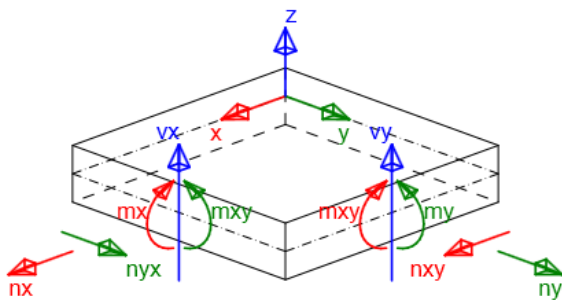

Sign convention of internal forces

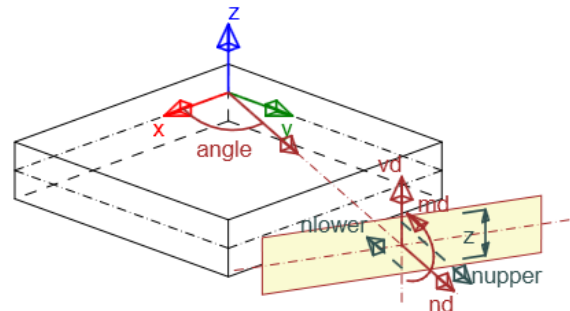

Recalculated internal forces in input direction by theory of Baumann

The recalculated internal forces using the Baumann Theory are displayed in the data window for the user defined internal forces.

Recalculated design forces

Design forces in centroidal plane for ULS combination

Angle [°]	Concrete strut	n upper [kN/m]	n lower [kN/m]	n d [kN/m]	m d [kNm/m]	v d [kN/m]
45,0	No	-755,56	755,56	0,00	119,00	60,00
135,0	No	-120,63	120,63	0,00	19,00	60,00

Design forces in centroidal plane for SLS Characteristic combination

Angle [°]	Concrete strut	n upper [kN/m]	n lower [kN/m]	n d [kN/m]	m d [kNm/m]	v d [kN/m]
0,0	No	-507,94	507,94	0,00	80,00	0,00
90,0	No	-507,94	507,94	0,00	80,00	0,00

Design forces in centroidal plane for SLS Quasi-permanent combination

Angle [°]	Concrete strut	n upper [kN/m]	n lower [kN/m]	n d [kN/m]	m d [kNm/m]	v d [kN/m]
0,0	No	-507,94	507,94	0,00	80,00	0,00
90,0	No	-507,94	507,94	0,00	80,00	0,00

Recalculated forces

Normal forces (design and in principal stress direction) at surfaces for ULS combination

Surface	Checked direction	n1 [kN/m]	n2 [kN/m]	α n1 [°]	z [mm]	Angle [°]	n surface [kN/m]
Upper	Principal stress direction	-120,63	-755,56	-45,0	153	-45,0	-120,63
Upper	Perpendicular direction	-120,63	-755,56	-45,0	153	45,0	-755,56
Upper	Compressive concrete strut	-120,63	-755,56	-45,0	153	90,0	0,00
Lower	Principal stress direction	755,56	120,63	45,0	158	45,0	755,56
Lower	Perpendicular direction	755,56	120,63	45,0	158	135,0	120,63

11.2.1 Ribbon group Recalculation of design forces

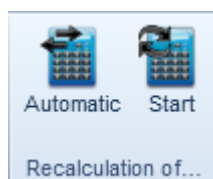

- **Automatic** – if the option is selected, the design forces are recalculated automatically after each change in the table of internal forces in section.
- **Start** – calculate design forces for the currently entered internal forces.

11.3 Second order effects

For the current section and current loads extreme (set in lists **Current section** and **Current extreme** in top of navigator), click navigator command **Current Section & Extreme > Second order effects** to launch the input-dialog of end moments acting in the compression member and to calculate the second order effects. The end moments can be entered only if the compression member type is used for the current section.

The end moment values, the recalculated internal forces, biaxial bending and slenderness are displayed in the Data window.

Ribbon group **Recalculation of internal forces** is available.

First order end moments

Combination type	Load type	My [kNm]	Mz [kNm]
Fundamental ULS	Begin	60,0	0,0
	End	0,0	0,0
Accidental	Begin	0,0	0,0
	End	0,0	0,0

i The first order end moments M01 and M02 acc. to 5.8.3.1 (1)

Data

Recalculation of internal forces (second order effect and imperfection)

Ultimate limit state - fundamental combination of actions

Axis	N_{ed} [kN]	$M_{ed,y/z}$ [kNm]	$M_{0,y/z}$ [kNm]	$M_{1,y/z}$ [kNm]	$M_{0Ed,y/z}$ [kNm]	$M_{2,y/z}$ [kNm]	$e_{0,z/y}$ [mm]	$e_{1,z/y}$ [mm]	$e_{0Ed,z/y}$ [mm]	$e_{2,z/y}$ [mm]	$e_{Ed,z/y}$ [mm]
y	-800,0	192,9	50,0	17,9	67,9	125,0	63	22	85	156	241
z	-800,0	16,0	0,0	4,5	16,0	0,0	0	6	20	0	20

Biaxial bending

λ_y / λ_z	λ_z / λ_y	$(e_{y/h_{eq}}) / (e_{z/b_{eq}})$	$(e_{z/b_{eq}}) / (e_{y/h_{eq}})$	Check
4,00	0,25		0,08	12,06
Uniaxial bending				

Nonconformity

Nonconformities	
i	Second order effects with respect to z-axis are ignored because the slenderness λ is below a certain value λ_{lim} (see EN 1992-1-1 article 5.8.3.1 (1)).

Slenderness

Axis	l [m]	l_0 [m]	i [mm]	A [-]	B [-]	C [-]	n [-]	λ [-]	λ_{lim} [-]	$\lambda \leq \lambda_{lim}$
y^\perp	5,00	10,00	115	0,77	1,21	0,70	0,21	86,60	28,08	2 nd order
z^\perp	5,00	2,50	115	0,92	1,21	0,70	0,21	21,65	33,74	1 st order

Nominal stiffness

Axis	K_c [-]	I_c [mm ⁴]	φ_{eff} [-]	I_s [mm ⁴]	k_2 [-]	EI [MNm ²]	N_B [kN]	c_0 [-]	β [-]
y^\perp	0,06	2133333333	1,50	45663540	0,11	13	-1246,6	9,60	1,03
z^\perp	0,00	2133333333	0,41	45663540	0,00	0	0,0	9,60	0,00
Axis	θ_1 [-]	α_m [-]	α_h [-]	ρ_m [-]	M_{01} [kNm]	M_{02} [kNm]			
y^\perp	0,00	1,00	0,89	1,00	60,0	0,0			
z^\perp	0,00	1,00	0,89	1,00	0,0	0,0			
A_c [mm ²]	A_s [mm ²]	k_1 [-]	K_s [-]	E_{cd} [MPa]	ω [-]	φ [-]			
160000	1963	1,32	1,00	28397,6	0,23	1,68			

11.3.1 Ribbon group Recalculation of internal forces

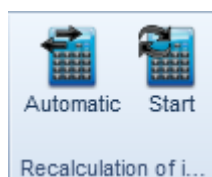

- **Automatic** – if the option is selected, the internal forces including second order effects and imperfections are recalculated after each change in the table of end moments.
- **Start** – calculate internal forces including effect of second order and imperfections for the currently defined end moments.

11.4 Load effects on staged sections

If IDEA RCS is started from superior application, forces staged sections may be set to read only.

Following combinations are used for check of staged sections:

- **Fundamental ULS** – values of internal forces defined in this combination type are used to perform ultimate limit states checks and detailing check.
- **Accidental** - values of internal forces defined in this combination type are used to perform ultimate limit states checks.
- **Max. cyclic loads** – the combination for fatigue check to calculate the maximal stress range.
- **Min. cyclic loads** - the combination for fatigue check to calculate the minimal stress range.
- **Characteristics combination** – values of internal forces defined in this combination type are used to perform stress limitation check
- **Frequent combination** – values of internal forces defined in this combination type are used to perform brittle failure check and crack width check.
- **Quasi-permanent combination** – values of internal forces defined in this combination type are used to perform stress limitation check, crack widths check, stiffness check.

Load effects are defined by particular components for staged sections– sum of permanent loads, sum of leading variable actions and sum of accompanying variable actions.

Ribbon groups **Load internal forces** and **Resultant of stage** are available.

Effects of design load (at the time of check)

Combination type	Use	Load type	N [kN]	Vy [kN]	Vz [kN]	T [kNm]	My [kNm]	Mz [kNm]
Fundamental ULS	<input checked="" type="checkbox"/>	Permanent Sum Gdj	0,0	0,0	100,0	0,0	3000,0	0,0
		Variable Sum Qdi	0,0	0,0	80,0	20,0	3000,0	0,0
		Effect of prestressing	-3048,7	0,0	0,0	0,0	-2722,2	61,0
Accidental	<input type="checkbox"/>	Permanent Sum Gdj	0,0	0,0	0,0	0,0	0,0	0,0
		Variable Sum Qdi	0,0	0,0	0,0	0,0	0,0	0,0
		Effect of prestressing	0,0	0,0	0,0	0,0	0,0	0,0
Characteristic	<input checked="" type="checkbox"/>	Permanent Sum Gdj	0,0	0,0	200,0	0,0	2700,0	0,0
		Variable Sum Qdi	0,0	0,0	50,0	0,0	2500,0	0,0
		Effect of prestressing	-3048,7	0,0	0,0	0,0	-2722,2	61,0
Frequent	<input checked="" type="checkbox"/>	Permanent Sum Gdj	0,0	0,0	200,0	0,0	2700,0	0,0
		Variable Sum Qdi	0,0	0,0	0,0	0,0	600,0	0,0
		Effect of prestressing	-3048,7	0,0	0,0	0,0	-2722,2	61,0
Quasi-permanent	<input checked="" type="checkbox"/>	Permanent Sum Gdj	0,0	0,0	200,0	0,0	2700,0	0,0
		Variable Sum Qdi	0,0	0,0	0,0	0,0	0,0	0,0
		Effect of prestressing	-3048,7	0,0	0,0	0,0	-2722,2	61,0

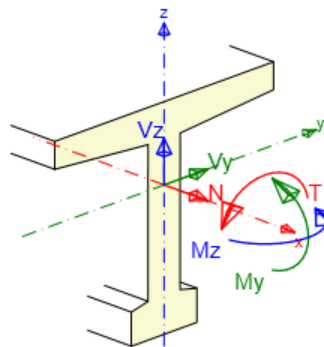

11.4.1 Taking load actions from action stages

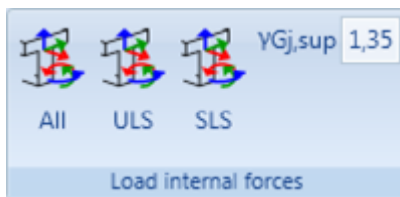

Components of permanent load actions for particular combinations can be taken from action stages. When taking load action from action stages, sum of all characteristics loads is created from all stages of the same or less age than the is the age of current loads extreme.

To take actions from stages use commands in ribbon **Load internal forces**.

- **All** – takes actions from action stages to all combination types in current loads extreme. Value of characteristic load for fundamental combination is multiplied by coefficient defined in $\gamma_{Gj,sup}$.
- **ULS** – takes actions from action stages to ultimate limit state combination in current loads extreme. Value of characteristic load for fundamental combination is multiplied by coefficient defined in $\gamma_{Gj,sup}$.
- **SLS** - takes actions from action stages to serviceability limit state combination in current loads extreme.

11.4.2 Ribbon group Resultant of stage

See [Ribbon group Resultant of stage](#).

12 Concrete reinforcement

For the current section (selected in **Current section** list at the top part of Navigator window) navigator command **Current section & Extreme > Reinforcement** launches the definition of longitudinal and shear reinforcement.

According to the type of current design member and shape of cross-section following ribbon groups are available:

- For beam and compression member: **Reinforcement, Import, export, Cross-section points** and **Calculation**.
- For one-way slab: **Reinforcement, Import, export, Cross-section points** and **Calculation**.
- For two-way slab: **Reinforcement, User settings, Longitudinal reinforcement, Delete, Import, export** and **Calculation**.

12.1 Concrete reinforcement of 1D members

Main commands for 1D reinforcement operations are collected in ribbon group **Reinforcement**.

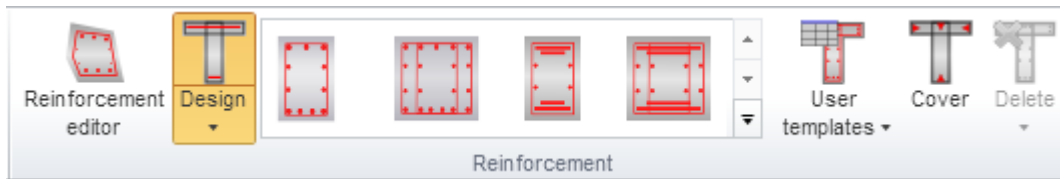

Commands in ribbon group **Reinforcement**:

- **Reinforcement editor** – launch input and modifications of 1D reinforcement using the Reinforcement editor – see **Editor of reinforcement of 1D members**.
- **Design** – switch on/off design of reinforcement (calculation of required number of bars) when applying reinforcement template – see **Reinforcement design**.
 - **Strut optimisation** – switch on/off performing the optimisation of concrete strut during design and check of reinforcement to achieve the optimal utilisation of truss analogy component selected in the code and calculation settings.
- **Reinforcement templates** – input cross-section reinforcement using predefined templates of reinforcement – see **Input of 1D members reinforcement by template**.
- **User templates** – input cross-section reinforcement using user defined templates of reinforcement – see **User defined reinforcement templates**.
- **Cover** – concrete cover definition on individual cross-section edges – see **Editing cover of 1D sections**.
- **Delete** – see **Deleting reinforcement**.

12.1.1 Editing cover of 1D sections

To edit concrete cover at particular cross-section edges click **Cover** in ribbon group **Reinforcement**. Values of cover related to particular cross-section edges can be changed in table. To switch drawing of existing reinforcement on/off select the option **Draw reinforcement**.

Reinforced cross-section covers
✕

	Component/Edge	c [mm]	
1	1/1	30	
2	1/2	30	
3	1/3	30	
4	1/4	30	
5	1/5	30	
6	1/6	30	
7	1/7	30	
8	1/8	30	
9	1/9	30	
10	1/10	30	
11	1/11	30	
12	1/12	30	
13	1/13	30	
14	1/14	30	
15	2/1	30	
16	2/2	30	
17	2/3	30	
18	2/4	30	

Draw reinforcement

OK
Cancel

12.1.2 Input of 1D members reinforcement by template

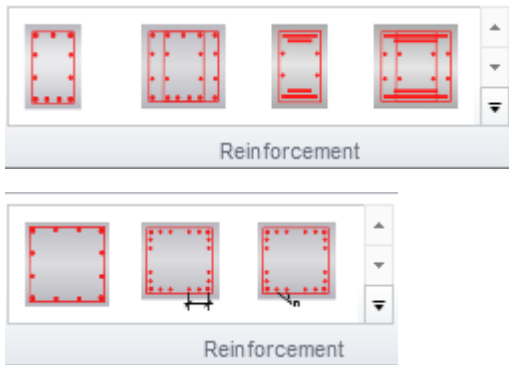

Reinforcement templates are available for some pre-defined sectional shapes. Reinforcement templates available for the current cross-section are displayed in ribbon group **Reinforcement**.

Click button with required reinforcement template to set the parameters of the inserted template in the settings dialog.

Reinforcement template parameters for I-shaped cross-section (including the reinforcement design):

Reinforcement layout for I-shaped cross-section
✕

Longitudinal reinforcement	
Number of upper bars n_{RB_U}	17
Upper bars diameter d_{ULR}	16 mm
Number of lower bars n_{RB_L}	15
Lower bars diameter d_{LLR}	16 mm
Number of edge bars n_{RB_S}	0
Side bars diameter d_{SLR}	10 mm
Steel grade	B 500B
Stirrups	
Stirrups diameter d_s	10 mm
Steel grade	B 500B
Diameter of mandrel by code	<input checked="" type="checkbox"/>
Torsion check	<input checked="" type="checkbox"/>
Stirrups cover c_s	30 mm
Stirrups distance	0,08 m
Maximum distance by code	<input checked="" type="checkbox"/>

Design summary

	$A_{s,d}$	$A_{s,p}$	Ratio [%]
Upper layer [mm ²]	3413	3418	99,9
Lower layer [mm ²]	2838	3016	94,1
Stirrups [mm ² /m]	1775	1963	90,4

Click **OK** to add the reinforcement into the cross-section.

For some cross-sections templates with special definition of reinforcement layout are available. Those templates enable to input reinforcement bars with different diameters in one reinforcement layer at once.

The reinforcement layer is defined by string, which describes diameters of individual bars in the layer. Individual diameters are separated by space, characters 'x' or '*' can be used to define multiple diameters, e. g. ,20 16 16 20' or ,20 2*16 20'.

Reinforcement layout
✕

Main longitudinal reinforcement	
Diameters in upper layer l_{U1}	12x22 mm
Diameters in upper layer l_{U2}	mm
Diameters in lower layer l_{L1}	10x20 mm
Diameters in lower layer l_{L2}	mm
Steel grade	B 500B
Distances between layers	Minimum distance
Longitudinal reinforcement for detailing	
Add detailing reinforcement	<input checked="" type="checkbox"/>
Detailing bars diameter d_{DR}	10 mm
Longitudinal reinforcement on side of cross-section	
Number of edge bars n_{RBs}	0
Side bars diameter d_{SLR}	10 mm
Stirrups	
Stirrups diameter d_s	10 mm
Steel grade	B 500B
Diameter of mandrel by code	<input checked="" type="checkbox"/>
Torsion check	<input checked="" type="checkbox"/>
Stirrups cover c_s	30 mm
Stirrups distance	0,14 m
Maximum distance by code	<input checked="" type="checkbox"/>

Design summary ⓘ

	$A_{s,d}$	$A_{s,p}$	Ratio [%]
Upper layer [mm ²]	4185	4562	91,8
Lower layer [mm ²]	3098	3142	98,6
Stirrups [mm ² /m]	1066	1122	95,0

12.1.3 Input of one-way slabs reinforcement by a template

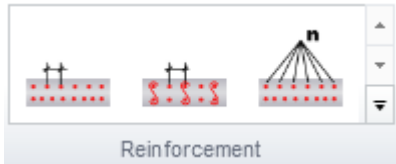

For one way slabs basic templates to define reinforcement at particular faces are available. Available templates are displayed in the ribbon group **Reinforcement**.

Reinforcement layout for one-way slab
✕

Longitudinal reinforcement	
Upper bars distance dist RB _U	280 mm
Lower bars distance dist RB _L	380 mm
Upper bars diameter d _U	10 mm
Lower bars diameter d _L	10 mm
Bars material	B 500B
Cover c _c	30 mm

Design summary

	A _{s,d}	A _{s,p}	Ratio [%]
Upper layer [mm ²]	276	280	98,5
Lower layer [mm ²]	204	207	98,8

For one way slabs the distance between bars or bars number, bars diameter, bars material and concrete cover are defined in the template dialog.

12.1.4 Editing stirrups

Stirrups defined by templates or in Reinforcement editor can be modified in tables in the Data window.

Properties of stirrup (selected by mouse in the Main window) are displayed in table in Data window.

Stirrups										Vertices	
Stirrup	Type	\emptyset [mm]	Material	s s [mm]	Shear	Torsion	n dm [-]	First edge length [mm]	Last edge length [mm]	Y [mm]	Z [mm]
1	Vertices derived from shape	8	B 500B	200	<input checked="" type="checkbox"/>	<input checked="" type="checkbox"/>	2,50			-66	733
2	Vertices derived from shape	8	B 500B	200	<input type="checkbox"/>	<input type="checkbox"/>	2,50	200	200	-66	-899
										66	-899
										66	733

According to selected stirrup type, the following properties can be adjusted in Data window:

- For a stirrup created from a template, it is possible to adjust the stirrup diameter, material characteristics and the distance between two adjacent stirrups, check type and radius of mandrel as a multiple of stirrup diameter. The positions of the stirrup vertices are listed in a Vertex table and can't be changed by the user.
- For separately user defined stirrups, there is a list of coordinates in the Vertex table. In this list, the coordinates are editable by user.

12.1.5 Editing links

Links defined by templates or in Reinforcement editor can be modified in tables in the Data window.

Properties of link (selected by mouse in the Main window) can be edited in the data window.

Layers of links												
Link	\emptyset [mm]	Distance [mm]	n [/m]	A s [mm ²]	s s [mm]	Edge link specification	Edge link distance [mm]	Upper cover [mm]	Lower cover [mm]	n dm [-]	Anchorage length [mm]	Material
1	6	200	5,00	141	200	Symmetrically	100	24	24	1,60	50	B 500B
2	6	200	5,00	141	200	User input	50	24	24	1,60	50	B 500B

Diameter, distance between axes of links, top cover, bottom cover, distance along the design member, mandrel diameter, anchorage length and material of the links layer can be edited in the **Layers of links** table.

12.1.6 Longitudinal reinforcement editing

Longitudinal reinforcement defined by templates or in Reinforcement editor can be modified in tables in the Data window.

Properties of longitudinal reinforcement (selected by mouse in the Main window) can be edited in the data window.

12.1.6.1 Editing common reinforcement properties

Identical properties for all bars

	Identical	Value
∅ [mm]	<input checked="" type="checkbox"/>	20
Material	<input checked="" type="checkbox"/>	B 500B 

Material and diameter of bars can be mass-edited for all reinforcement bars of longitudinal reinforcement of 1D and 2D members.

Common bar properties can be edited in table **Identical properties for all bars**. If checkbox in column Identical is checked, diameter of all bars or material of bars can be set in column **Value**.



If the checkbox **Identical** is checked, column for editing of reinforcement diameter or column for editing of material is not available in main tables for reinforcement editing.

12.1.6.2 Properties of longitudinal reinforcement layers

According to the selected 1D design member's longitudinal reinforcement type, the following properties can be adjusted in Data window:



- For a reinforcement layer created from a template, it is possible to adjust the number of bars in table **Reinforcement layers**. The properties of bars in the selected layer are listed in the table **Layer details**, where the bent-up bars can be defined – see **Layer details**. Coordinates of individual bars cannot be changed.

Reinforcement layers

Layer	Type	∅ [mm]	n	As [mm ²]	Material	Begin Y [mm]	Begin Z [mm]	End Y [mm]	End Z [mm]
1	Uniform layer	16	4	804	B 500B 	90	202	-90	202
2	Uniform layer	16	4	804	B 500B 	-90	-202	90	-202

- For a reinforcement layer defined by the diameters layout it is possible to modify the layout of bars in individual layers, the definition mode of calculation of distance between layers or the distance between layers in table **Reinforcement layers**. The properties of bars in the selected layer are listed in the table **Layer details**, where the bent-up bars can be defined – see **Layer details**. Coordinates of individual bars cannot be changed.

Reinforcement layers

Layer	Bars in layer 1	Bars in layer 2	Bars in layer 3	Bars in layer 4	Bars in layer 5	As [mm ²]	Material	Distances between layers	User distance [mm]
1	2x16					402	B 500B 	Minimum distance	
2	3x20					942	B 500B 	Minimum distance	

- For a reinforcement layer defined by coordinates of beginning and end point, it is also possible to change the start and end point of a layer in table **Reinforcement layers**. The properties of bars in the selected layer are listed in the table **Layer details**, where the bent-up bars can be defined – see **Layer details**. Coordinates of individual bars cannot be changed.

Reinforcement layers

Layer	Type	\emptyset [mm]	n	As [mm ²]	Material	First point Origin	distance Y [mm]	distance Z [mm]	Begin Y [mm]	Begin Z [mm]	Last point Origin	distance Y [mm]	distance Z [mm]	End Y [mm]	End Z [mm]
1	Uniform layer	16	4	804	B 500B	vertex 1	30	30	-120	-220	vertex 1	270	30	120	-220
2	Uniform layer	16	4	804	B 500B	vertex 4	30	-30	-120	220	vertex 4	270	-30	120	220

- For a reinforcement layer defined at cross-section edge, value of cover to particular cross-section edges can be edited in table **Reinforcement layers on cross-section edge**. The properties of bars in the selected layer are listed in the table **Layer details**, where the bent-up bars can be defined – see **Layer details**. Coordinates of individual bars cannot be changed.

Reinforcement layers

Layer	Type	\emptyset [mm]	n	As [mm ²]	Material	Begin Y [mm]	Begin Z [mm]	End Y [mm]	End Z [mm]
1	Uniform layer	16	4	804	B 500B	-112	-212	112	-212
2	Uniform layer	16	4	804	B 500B	112	212	-112	212

- For individual user defined bars, there is a list of coordinates and bends in the **Reinforcement bars table**. Here, the coordinates and bends properties are editable by the user.

Reinforcement bars

Layer	Type	\emptyset [mm]	As [mm ²]	Material	First point Origin	distance Y [mm]	distance Z [mm]	Y [mm]	Z [mm]	Bent-up	s _b [m]	α_{XZ} [°]	α_{YZ} [°]
3	Single bar	16	201	B 500B	Point (0,0)	-112	-212	-112	-212	<input type="checkbox"/>			
4	Single bar	16	201	B 500B	Point (0,0)	-37	-212	-37	-212	<input type="checkbox"/>			

- For the one way slab reinforcement layers created by template using the distance between bars the diameter of bars and the distance between centres of adjacent bars can be edited in the table **Reinforcement layers**. The properties of bars in the selected layer are listed in the table **Layer details**. Coordinates of individual bars cannot be changed.

Reinforcement layers

Layer	Type	\emptyset [mm]	n	Distance [mm]	As [mm ²]	Material	Begin Y [mm]	Begin Z [mm]	End Y [mm]	End Z [mm]
1	Uniform layer	10		250	314	B 500B	-375	65	375	65
2	Uniform layer	10		200	393	B 500B	-400	-65	400	-65

- For the one way slab reinforcement layers created by template using the number of bars in layer the diameter of bars and the number of bars in layer can be edited in the table **Reinforcement layers**. The properties of bars in the selected layer are listed in the table **Layer details**. Coordinates of individual bars cannot be changed.

Reinforcement layers

Layer	Type	\emptyset [mm]	n	As [mm ²]	Material	Begin Y [mm]	Begin Z [mm]	End Y [mm]	End Z [mm]
1	Uniform layer	16	6	1206	B 500B	462	62	-462	62
2	Uniform layer	16	8	1608	B 500B	-462	-62	462	-62

- For the one way slab reinforcement layers created by definition of spacing the distance between adjacent bars, the mode of edge bar definition, the distance of the edge bar to the cross-section edge and the cover can be edited in the table **Reinforcement layers for one-way slab**. The properties of bars in the selected layer are listed in the table **Layer details**. Coordinates of individual bars cannot be changed.

Reinforcement layers for one-way slab

Layer	Type	\emptyset [mm]	n [/m]	Distance [mm]	Edge bar specification	Edge bar distance [mm]	As [mm ²]	Surface for cover	Cover [mm]	Material
1	Uniform layer	10	5,00	200	Symmetrically	100	393	Lower	20	B 500B
2	Uniform layer	10	5,00	200	User input	195	393	Upper	30	B 500B

If proper checkboxes **Identical** are selected in table **Identical properties for all bars**, diameter or material of reinforcement bar can be changed in this table. If checkboxes are off, diameter or material can be edited in table of particular reinforcement type.

12.1.6.3 Layer details

Layer details

Bar	\emptyset [mm]	Material	Y [mm]	Z [mm]	Bent-up	s _b [m]	α XZ [°]	α YZ [°]
5	20	B 500B	-52	-885	<input type="checkbox"/>			
6	20	B 500B	0	-885	<input type="checkbox"/>			
7	20	B 500B	52	-885	<input type="checkbox"/>			
8	20	B 500B	-52	-844	<input type="checkbox"/>			
9	20	B 500B	52	-844	<input type="checkbox"/>			

Properties of individual bars in current layer are displayed in table **Layer details**. Columns in the table:

- **Bar** – index of bar is displayed.
- \emptyset – bar diameter is displayed.
- **Y**,
- **Z** – distance of bar centre from cross-section centroid in direction of appropriate axis is displayed.
- **Bent-up** – switch on/off the bent-up bar.
- **sb** – input distance between individual bent-ups.
- α XZ – input angle of bent-up bar in XZ plane of cross-section (to longitudinal axis of member).
- α YZ – input angle of bent-up bar in YZ plane of cross-section (to longitudinal axis of member).

12.2 Editor of reinforcement of 1D members

To launch reinforcement editor click **Reinforcement editor** in ribbon group **Reinforcement** in navigator command **Current Section & Extreme > Reinforcement**.

Current reinforced section is displayed in the main window of reinforcement editor.

Following tabs are displayed in the data window of reinforcement editor:

- **Cover** – table of concrete cover on individual cross-section edges is displayed.
- **Stirrups** – tables of stirrups properties are displayed.
- **Longitudinal reinforcement** – tables of longitudinal reinforcement properties are displayed.

Ribbon groups **Reinforcement input**, **User settings**, **Reinforcement** and **View settings** are available.

Layer	Type	As [mm ²]	Material
> 2	Uniform layer	1571	B 500B
4	Single bar	616	B 500B
5	Single bar	616	B 500B
7	Uniform layer	1232	B 500B
8	Uniform layer	628	B 500B
9	Uniform layer	628	B 500B

Layer	Bars	
▲	Layer details	
	Ø [mm]	20
	n	5
	Edge	4
	Cover	As defined in cross-section

12.2.1 Editing cover

To edit concrete cover at particular cross-section edges click **Cover** in ribbon group **Reinforcement**.

Values of cover related to particular cross-section edges can be changed in table.

To switch drawing of existing reinforcement on/off select the option **Draw reinforcement**.

Concrete cover at particular cross-section can be modified in table on tab **Cover**.

Cover can be defined:

- to individual cross-section edges, if option **All edges** is selected.
- to individual cross-section surfaces, if option **All edges** is not selected.

Covers All edges

	Type	Cover [mm]
>	Lower edge	30
	Upper edge	30
	Other edges	30

Covers All edges

	Edge	Cover [mm]
>	1	30
	2	30
	3	30
	4	30
	5	30
	6	30
	7	30
	8	30

12.2.2 Input of reinforcement by template

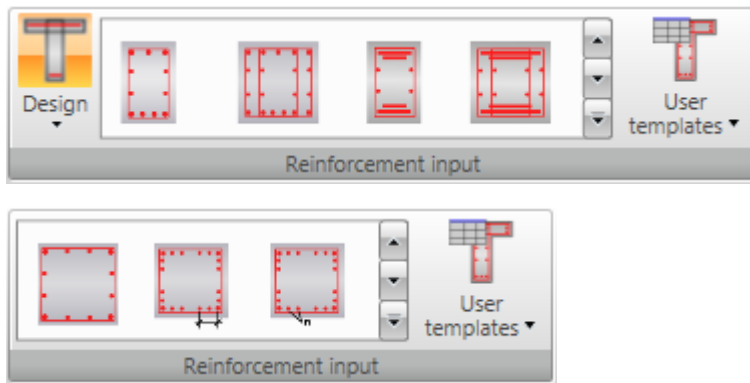

Reinforcement templates are available for some pre-defined sectional shapes. Reinforcement templates available for the current cross-section are displayed in ribbon group **Reinforcement**.

Click button with required reinforcement template to set the parameters of the inserted template in the settings dialog.

- **Design** – switch on/off design of reinforcement (calculation of required number of bars) when applying reinforcement template – see **Reinforcement design**.
 - **Strut optimisation** – switch on/off performing the optimisation of concrete strut during design and check of reinforcement to achieve the optimal utilisation of truss analogy component selected in the code and calculation settings.
- **User templates** – input cross-section reinforcement using user defined templates of reinforcement – see **User defined reinforcement templates**.

Reinforcement template parameters for I-shaped cross-section (including the reinforcement design):

Reinforcement layout for I-shaped cross-section
✕

Longitudinal reinforcement		
Number of upper bars n_{RB_U}		17
Upper bars diameter d_{ULR}		16 mm
Number of lower bars n_{RB_L}		15
Lower bars diameter d_{LLR}		16 mm
Number of edge bars n_{RB_S}		0
Side bars diameter d_{SLR}		10 mm
Steel grade	B 500B	
Stirrups		
Stirrups diameter d_s		10 mm
Steel grade	B 500B	
Diameter of mandrel by code	<input checked="" type="checkbox"/>	
Torsion check	<input checked="" type="checkbox"/>	
Stirrups cover c_s		30 mm
Stirrups distance		0,08 m
Maximum distance by code	<input checked="" type="checkbox"/>	

Design summary

Recalculate

	$A_{s,d}$	$A_{s,p}$	Ratio [%]
Upper layer [mm ²]	3413	3418	99,9
Lower layer [mm ²]	2838	3016	94,1
Stirrups [mm ² /m]	1775	1963	90,4

OK

Cancel

Click **OK** to add the reinforcement into the cross-section.

For some cross-sections templates with special definition of reinforcement layout are available. Those templates enable to input reinforcement bars with different diameters in one reinforcement layer at once.

The reinforcement layer is defined by string, which describes diameters of individual bars in the layer. Individual diameters are separated by space, characters 'x' or '*' can be used to define multiple diameters, e. g. ,20 16 16 20' or ,20 2*16 20'.

Reinforcement layout
✕

Main longitudinal reinforcement	
Diameters in upper layer l_{u1}	12x22 mm
Diameters in upper layer l_{u2}	mm
Diameters in lower layer l_{L1}	10x20 mm
Diameters in lower layer l_{L2}	mm
Steel grade	B 500B
Distances between layers	Minimum distance

Longitudinal reinforcement for detailing	
Add detailing reinforcement	<input checked="" type="checkbox"/>
Detailing bars diameter d_{DR}	10 mm

Longitudinal reinforcement on side of cross-section	
Number of edge bars n_{RBs}	0
Side bars diameter d_{SLR}	10 mm

Stirrups	
Stirrups diameter d_s	10 mm
Steel grade	B 500B
Diameter of mandrel by code	<input checked="" type="checkbox"/>
Torsion check	<input checked="" type="checkbox"/>
Stirrups cover c_s	30 mm
Stirrups distance	0,14 m
Maximum distance by code	<input checked="" type="checkbox"/>

Design summary Recalculate

	$A_{s,d}$	$A_{s,p}$	Ratio [%]
Upper layer [mm ²]	4185	4562	91,8
Lower layer [mm ²]	3098	3142	98,6
Stirrups [mm ² /m]	1066	1122	95,0

OK
Cancel

12.2.3 Input of one-way slabs reinforcement by a template

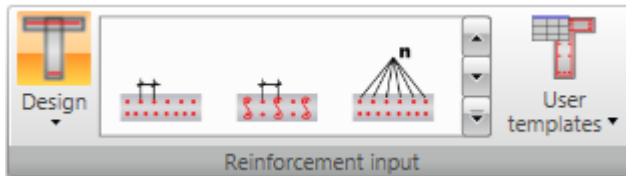

For one way slabs basic templates to define reinforcement at particular faces are available. Available templates are displayed in the ribbon group **Reinforcement**.

- **Design** – switch on/off design of reinforcement (calculation of required number of bars) when applying reinforcement template – see **Reinforcement design**.
- **Strut optimisation** – switch on/off performing the optimisation of concrete strut during design and check of reinforcement to achieve the optimal utilisation of truss analogy component selected in the code and calculation settings.
- **User templates** – input cross-section reinforcement using user defined templates of reinforcement – see **User defined reinforcement templates**.

Longitudinal reinforcement	
Upper bars distance dist RB_U	280 mm
Lower bars distance dist RB_L	380 mm
Upper bars diameter d_U	10 mm
Lower bars diameter d_L	10 mm
Bars material	B 500B
Cover c_c	30 mm

Design summary			
	$A_{s,d}$	$A_{s,p}$	Ratio [%]
Upper layer [mm ²]	276	280	98,5
Lower layer [mm ²]	204	207	98,8

For one way slabs the distance between bars or bars number, bars diameter, bars material and concrete cover are defined in the template dialog.

12.2.4 Reinforcement design

The reinforcement design can be performed, when applying reinforcement template on design members of type **Beam** and **One-way slab**.

To perform the design, option **Design** in ribbon group **Input by reinforcement templates** must be switched on.

The design of number of longitudinal reinforcement bars and design of stirrups distance according to the current reinforcement diameters is performed, when launching the dialog of reinforcement template. The design is performed respecting all load extremes, which are assigned to the current reinforced cross-section. ULS checks of capacity N-M-N , shear, torsion, interaction and crack width check should satisfy for the designed reinforcement.

Table of reinforcement areas of longitudinal and shear reinforcement is displayed in the bottom part of reinforcement template dialog:

- **As,d** – designed area of required reinforcement.
- **As,p** – area of real reinforcement of required reinforcement.
- **Ratio** – ratio of designed area to the real reinforcement area.
- **Recalculate** – button gets active after change of reinforcement template parameters. Click the button to perform new design of number of longitudinal reinforcement bars and design of stirrups distance, respecting the current diameters of appropriate reinforcement bars.
-  - displays tooltip describing design assumptions.

Design summary 

Recalculate

	$A_{s,d}$	$A_{s,p}$	Ratio [%]
Upper layer [mm ²]	5066	5309	95,4
Lower layer [mm ²]	2796	2815	99,3
Stirrups [mm ² /m]	1066	1122	95,0

12.2.5 Shear reinforcement

Shear reinforcement of beams and columns is defined using stirrups. Shear reinforcement of one-way slabs is defined using links.

12.2.5.1 Stirrups

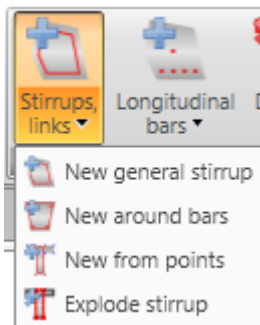

Drop-down button **Stirrups, links** in ribbon group **Reinforcement** collects commands for stirrups operations:

- **New general stirrup** – adds a new stirrup by coordinates of stirrup vertices and stirrup diameter.
- **New around bars** – adds a new stirrup by vertices defined by selection of longitudinal reinforcement bars.
- **New from points** – adds a new stirrup by vertices defined by selection of cross-section vertices.
- **New links** – adds a new layer of links into the cross-section of beam-slab.
- **Explode stirrup** – stirrups defined by templates can be transformed to a generally defined (general) stirrup with editable vertices. Particular vertices of stirrup than can be edited as by stirrup defined by points.

Stirrups defined in cross-section are displayed on tab **Stirrups** in the data window in table **Stirrups**. Properties of selected stirrup are displayed in property table.

Columns in **Stirrups** table:

- **Type** – mode of stirrup definition is displayed.
- \emptyset – input value of stirrup diameter.
- **Material** – select stirrup material.
- **Distance** – input value of longitudinal distance between stirrups.
- **Shear** – if the checkbox is checked, stirrup is taken into account for shear check.
- **Torsion** – if the checkbox is checked, stirrup is taken into account for torsion check.

The screenshot displays the software interface for defining stirrups. The top part shows a 3D model of a column with a cross-section. The cross-section is a rectangle with a top flange. Vertices are numbered 1 through 8. A coordinate system with x, y, and z axes is shown. A red rectangular stirrup is shown around the column, with dimensions 1632 and 1332. A detail of the stirrup is shown to the right, with dimensions 89, 382, 264, 264, 200, and 200.

Below the model is a 'Data' panel with tabs for 'Covers', 'Stirrups', and 'Longitudinal reinforcement'. The 'Stirrups' tab is active, showing buttons for 'New', 'New around bars', 'New from points', and 'Explode stirrup'.

	Type	Ø [mm]	Material	Distance [mm]	Shear	Torsion	Stirrup	Vertexes
>	1	Vertexes derived from shape 8	B 500B	200	<input checked="" type="checkbox"/>	<input checked="" type="checkbox"/>	<input checked="" type="checkbox"/>	Stirrup detail
	2	Vertexes derived from shape 8	B 500B	200	<input type="checkbox"/>	<input type="checkbox"/>	<input checked="" type="checkbox"/>	n dm <input type="text" value="2,5"/>

12.2.5.1.1 General stirrups

The general stirrup shape is defined by coordinates of the stirrup vertices. A vertex is the intersection of two stirrup branches axes.

To input new general stirrup click **Stirrups, links > New general stirrup** in ribbon group **Reinforcement** or click **New** above the table **Stirrups**.

Properties group **Stirrup detail**:

- **n dm** – input value of mandrel diameter.
- **Closed** – if the option is selected, stirrup branch between first and last vertex is created automatically.
- **Origin** - vertex coordinates are related to point, which is selected in the list:
- **Point [0,0]** – vertex coordinates are related to origin of cross-section coordinate system.
- **Cross-section vertex** – vertex coordinates are related to vertex, which is selected in list below.

	Y [mm]	Z [mm]	Ycg [mm]	Zcg [mm]		
>	50	50	-100	-200		
	250	50	100	-200		
	250	450	100	200		
	50	450	-100	200		

Stirrup vertices are defined in the table on **Vertices** tab. Coordinates can be copied from Microsoft Excel table also.



- **Y**,
- **Z** – input vertex coordinate related to the selected origin.
- **Ycg**,
- **Zcg** – vertex coordinate related to the centroid of cross-section is displayed.
- - adds new vertex row to the table..
- - deletes appropriate row from the table.

12.2.5.1.2 Stirrups around bars of longitudinal reinforcement

To input stirrup around main reinforcement click **Stirrups, links > New around bars** in ribbon group **Reinforcement** or click **New around bars** above the table **Stirrups**.

Stirrup shape is defined by selection of longitudinal reinforcement bars.

Following two options are available to create selection of bars:

- Sequential selection of bar numbers in **Reinforcement bar** lists .Click  to add new item behind current row. Click  to delete current row.
- Gradually, bars of longitudinal reinforcement are selected by mouse. Stirrup is generated around selected bars. Selected bars are listed in **Reinforcement bars** list. After selection of bars is finished, list of bars (stirrup vertices) can be edited.

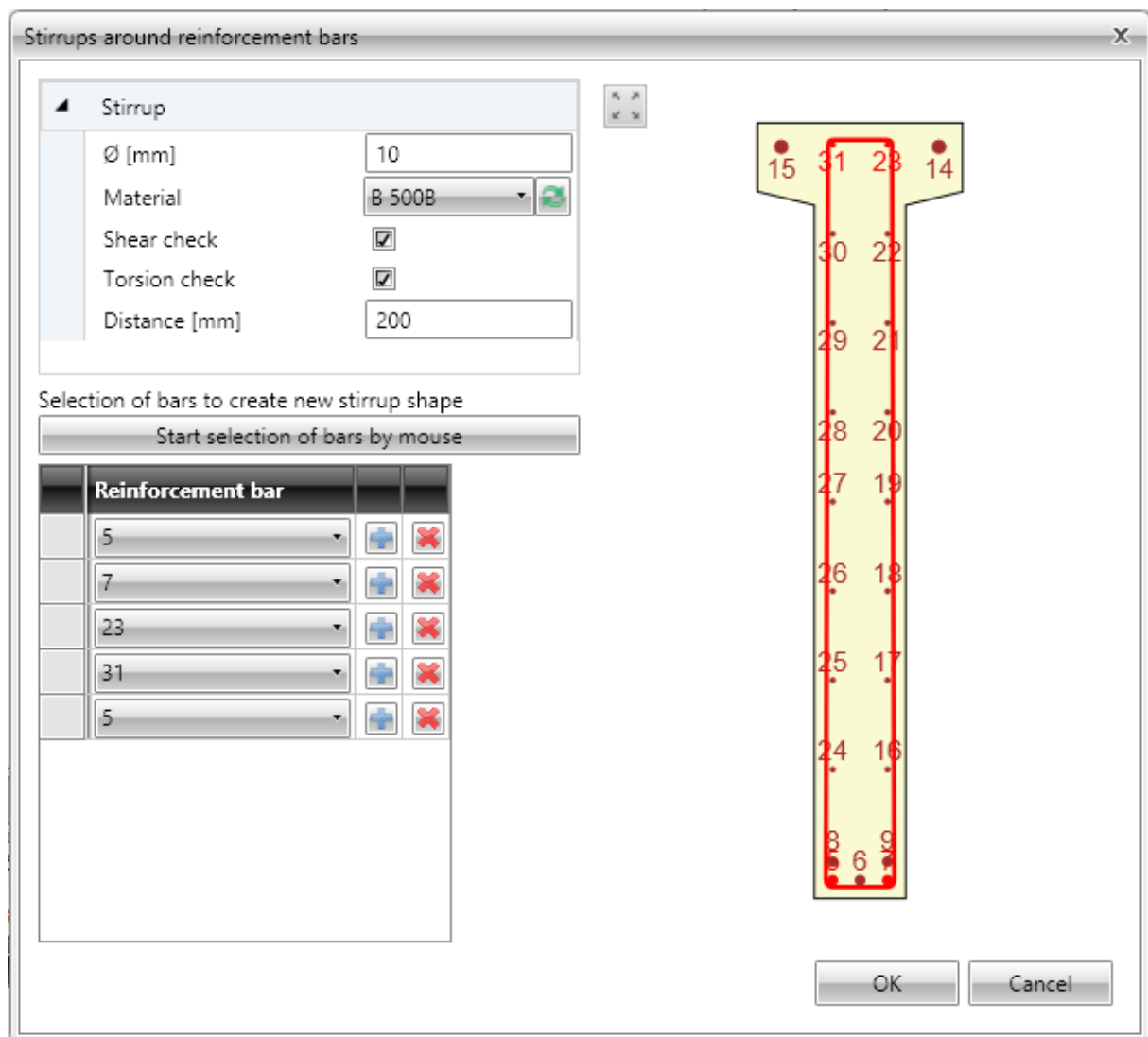

Particular dialog options:

- **Ø** – input value of stirrup diameter.
- **Material** – select or edit material of stirrup.
- **Shear check** – if selected, stirrup is taken into account for shear check.
- **Torsion check** – if selected, stirrup is taken into account for torsion check.

- **Distance** – input value of longitudinal distance between stirrups
- **Start selection of bars by mouse** – click to start selection of bars to create stirrup around them.

If the selection is in progress, command **Start selection of bars** is replaced by commands:

- **Finish selection of bars** – finishes selection of bars, **Close stirrup** and **Step back** disappear. Stirrup is not closed automatically.
- **Close stirrup** – closes stirrup creating branch between first and last defined point, finishes selection of bars.
- **Step back** – deletes last defined stirrup branch.



12.2.5.1.3 Stirrup by cross-section vertices

To input stirrup around main reinforcement click **Stirrups, links > New from points** in ribbon group **Reinforcement** or click **New from points** above the table **Stirrups**.

Stirrup shape is defined by selection of cross-section vertices. Particular points determine particular vertices of stirrup.

Points are selected by mouse in the picture of cross-section. The created stirrup passes through selected points.

Following two options are available to create stirrup vertices:

- Sequential selection of vertex number in **Point** lists .Click  to add new item behind current row. Click  to delete current row.
- Gradually, points are selected by mouse. Stirrup is generated by selected points. Selected points are listed in **Point** list. After selection of points is finished, list of points (stirrup vertices) can be edited.

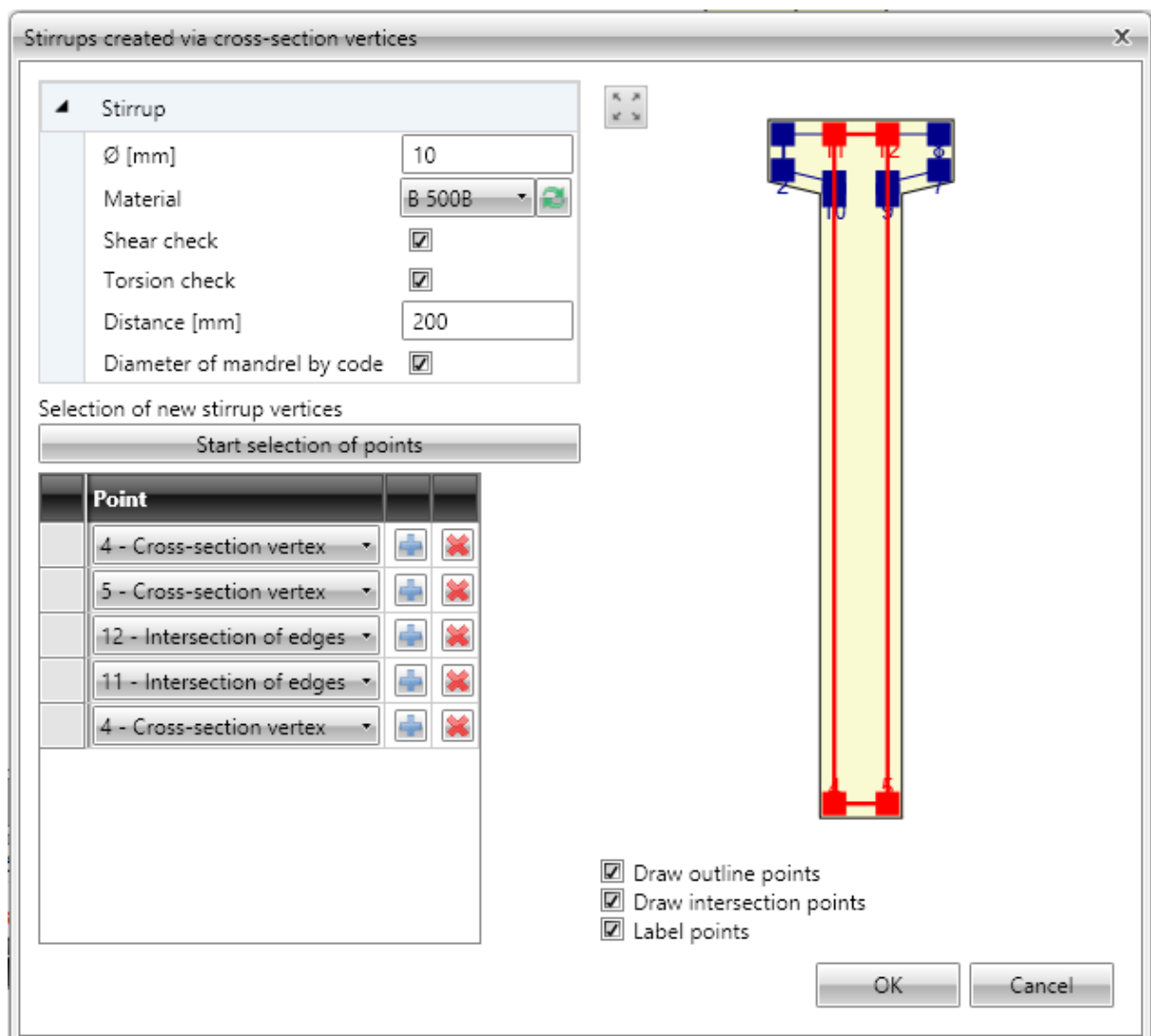

Particular dialog options:

- **Ø** – input value of stirrup diameter.
- **Material** – select or edit material of stirrup.

- **Shear check** – if selected, stirrup is taken into account for shear check.
- **Torsion check** – if selected, stirrup is taken into account for torsion check.
- **Distance** – input value of longitudinal distance between stirrups.
- **Diameter of mandrel by code** – switch on/off automatic determination of stirrup mandrel diameter by national code.
 - **ndm** – input value of mandrel diameter.
- **Start selection of points** – click to start selection of points to create stirrup.
If the selection is in progress, command **Start stirrup shape definition** is replaced by commands:
 - **Finish selection of points** – finishes selection of points, **Close stirrup** and **Step back** disappear. Stirrup shape is not closed automatically.
 - **Close stirrup** – closes stirrup creating branch between first and last defined point, finishes selection of bars.
 - **Step back** – deletes last defined stirrup branch.
- **Draw outline points** – switch on/off drawing of points in vertices of the cross-section outline offset. The offset corresponds to the cover defined at particular cross-section edges.
- **Draw opening points** – switch on/off drawing of points in vertices of the cross-section opening offset. The offset corresponds to the cover defined at particular opening edges.
- **Draw intersections points** – switch on/off drawing of points in intersections of offset edges of cross-section outline and cross-section opening.
- **Label points** – switch on/off drawing of numbers of points.

12.2.5.1.4 Exploding stirrups

To convert stirrup to general stirrup defined by vertices click **Explode stirrup** in ribbon group **Stirrups**.

12.2.5.2 Links

Shear reinforcement of one-way slabs is defined using links.

Links defined in cross-section are displayed on tab **Links** in the data window in table **Layers of links**. Properties of selected link are displayed in property table.

Columns in **Link layers** table:

- \emptyset – input diameter of link bar.
- **Distance** – input the distance between axes of links in the plane of cross-section.
- **n** – the calculated number of links per meter is displayed.
- **As** – the reinforcement area of all links in the layer is displayed.
- **Ss** – input the distance between links along the design beam.
- **cu** – input the value of concrete cover at the top edge of the cross-section.
- **cl** – input the value of concrete cover at the lower edge of the cross-section.
- **ndm** – input the requested value of mandrel diameter as multiple of link bar diameter.
- **lbd** – input the requested value of anchorage length.
- **Material** – select material of link bar.
-  - delete links layer.

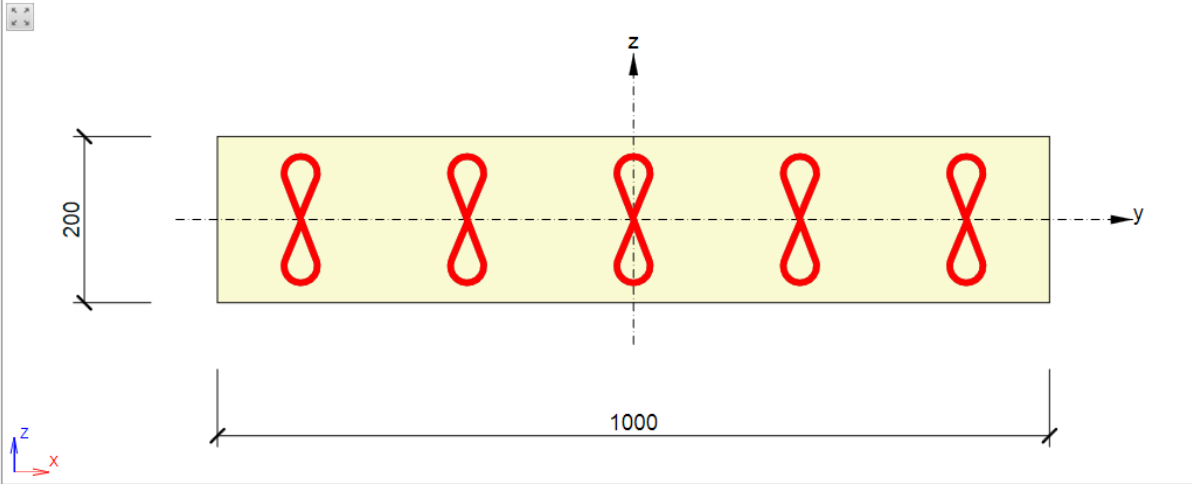

The diagram shows a rectangular cross-section of a slab with a width of 1000 mm and a height of 200 mm. Five red links are shown in a horizontal row. A coordinate system (x, y, z) is shown at the bottom left. The z-axis is vertical, the y-axis is horizontal along the width, and the x-axis is horizontal along the height.

Data

Covers Longitudinal reinforcement Links

Layers of links

Link	\emptyset [mm]	Distance [mm]	n [-]	As [mm ²]	Ss [mm]	cu [mm]	cl [mm]	n dm [-]	lbd [mm]	Material	Link layer details
> 1	8	200	5,00	251	200	20	20	4,00	50	B 500B	Edge bar specification <input type="button" value="Symmetrically"/>

12.2.5.2.1 Links layer

To input new layer of links click **Stirrups, links > New links** in ribbon group Reinforcement or click **New** above the table **Layers of links**.

Link layer details	
Edge bar specification	User input
Edge bars distance [mm]	50

Properties group **Link layer details**:

- **Edge bar specification** – select mode of edge bar definition:
 - **Symmetrically** – links are positioned automatically to get the same distance between edge links and cross-section edges.
 - **User input**
 - **Edge bars distance** – input distance of first link from the cross-section edge.

12.2.6 Longitudinal reinforcement

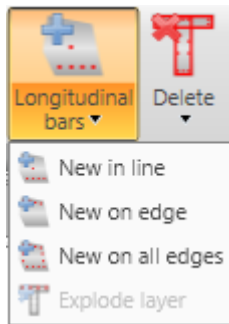

Drop-down button **Longitudinal bars** in ribbon group **Reinforcement** collects commands for longitudinal reinforcement operations:

- **New in line** - adds a new layer of longitudinal reinforcement defined by coordinates of edge bars.
- **New on edge** - adds a new layer of longitudinal reinforcement related to cross-section edge.
- **New on all edges** - adds new layers of longitudinal reinforcement on all edges of cross-section.
- **New in waves** - adds a new layer of longitudinal reinforcement into the wave of trapezoidal plate. Command is available only for one-way slabs.
- **New by spacing** – input of new longitudinal reinforcement layer at the edge by the spacing of bars. This input mode is available for one way slabs only.
- **Explode layer** – the longitudinal reinforcement defined from templates can be transformed to separate longitudinal bars with editable coordinates. Exploding of reinforcement layer is not available for reinforcement of 2D members.

Longitudinal reinforcement is defined by layers. A layer is defined by the number of bars in the layer and position. Position can be specified by:

- coordinates of the first bar in the layer, and the coordinates of the last bar in the layer,
- edge, to which the layer is related and offsets of bars layer from the edge.

Bar diameter and material can be assigned to individual layers.

List of defined layers is displayed in the table **Longitudinal reinforcement** on the **Longitudinal reinforcement** tab in the data window. For the selected bars layer a table of properties is displayed.

Longitudinal reinforcement

Layer	Type	As [mm ²]	Material		
> 1	Uniform layer	942	B 500B		
2	Single bar	616	B 500B		
3	Single bar	616	B 500B		
4	Uniform layer	1232	B 500B		
5	Uniform layer	628	B 500B		
6	Uniform layer	628	B 500B		
7	Uniform layer	452	B 500B		
8	Uniform layer	452	B 500B		

Layer Bars

Layer details

Ø [mm]

n

First point

Origin

Y [mm]

Z [mm]

Last point

Origin

Y [mm]

Z [mm]

Columns in **Longitudinal reinforcement** table:

- **Type** – mode of layer definition is displayed.
- **As** – calculated value of reinforcement area in layer is displayed.
- **Material** – materials select material of bars in reinforcement layer.
- - delete the appropriate reinforcement layer.

12.2.6.1 Layer of reinforcement by coordinates

To input new layer of reinforcement defined by coordinates click **Longitudinal bars > New in line** in ribbon group **Reinforcement** or click **New in line** above the table **Longitudinal reinforcement**.

Layer	Bars
Layer details	
∅ [mm]	16
n	2
First point	
Origin	vertex 1
Δ Y [mm]	50
Δ Z [mm]	50
Y [mm]	-175
Z [mm]	-800
Last point	
Origin	vertex 2
Δ Y [mm]	-50
Δ Z [mm]	50
Y [mm]	175
Z [mm]	-800

Properties of reinforcement layer specified by coordinates on **Layers** tab:

Properties group **Layer details**:

- **∅** – input diameter of bars in reinforcement layer.
- **n** – input number of bars in reinforcement layer.

Properties group **First point**:

- **Origin** – select origin, to which coordinates of first bar in layer are related. Position of bar can be related to point [0;0] (center of gravity) or to selected cross-section vertex.
- **ΔY**,
- **ΔZ** – input distance of first bar in layer to the selected origin in direction of the corresponding axis.
- **Y**,
- **Z** – coordinates of first bar in layer to the center of gravity in direction of the corresponding axis are displayed.

Properties group **Last point**:

- **Origin** – select origin, to which coordinates of last bar in layer are related. Position of bar can be related to point [0;0] (center of gravity) or to selected cross-section vertex.
- **ΔY**,
- **ΔZ** – input distance of last bar in layer to the selected origin in direction of the corresponding axis.
- **Y**,

- **Z** – coordinates of last bar in layer to the center of gravity in direction of the corresponding axis are displayed

12.2.6.1.1 Layer details

Layer		Bars						
	Bar	\emptyset [mm]	Y [mm]	Z [mm]	Bent-up	sb [m]	α_{xz} [°]	α_{yz} [°]
>	5	16	-175	-800	<input type="checkbox"/>			
	6	16	175	-800	<input type="checkbox"/>			

Properties of individual bars in current layer are displayed on tab **Bars**. Columns in the table:

- **Bar** – index of bar is displayed.
- \emptyset – bar diameter is displayed.
- **Y**,
- **Z** – distance of bar centre from cross-section centroid in direction of appropriate axis is displayed.
- **Bent-up** – switch on/off the bent-up bar.
- **sb** – input distance between individual bent-ups.
- **α_{XZ}** – input angle of bent-up bar in XZ plane of cross-section (to longitudinal axis of member).
- **α_{YZ}** – input angle of bent-up bar in YZ plane of cross-section (to longitudinal axis of member).

12.2.6.2 Layer of reinforcement on edge

To input new layer of reinforcement on cross-section edge click **Longitudinal bars > New on edge** in ribbon group **Reinforcement** or click **New on edge** above the table **Longitudinal reinforcement**.

Layer	Bars
▲ Layer details	
∅ [mm]	16
n	2
Edge	1
Cover	As defined in cross-section

Properties of reinforcement layer on cross-section edge on **Layers** tab:

Properties group **Layer details**:

- **∅** – input diameter of bars in reinforcement layer.
- **n** – input number of bars in layer.
- **Edge** – select edge, to which layer of reinforcement is related.
- **Cover** – select mode of cover determination in the list. Following modes can be selected:
 - **As defined in cross-section** – values of cover are taken from cross-section shape. Existing stirrups are taken into account.
 - **User defined** – values of cover can be entered in columns **Edge cover**, **Left cover**, **Right cover**.

Properties of individual bars of the layer are displayed on tab **Bars** – see **Layer details**.

12.2.6.3 Layers of reinforcement on all edges

To input new layers of reinforcement on all cross-section edges click **Longitudinal bars > New on all edges** in ribbon group **Reinforcement** or click **New on all edges** above the table **Longitudinal reinforcement**.

One reinforcement layer is created on each edge of cross-section. Number of bars on the edge is determined automatically respecting the given maximal distance between bars and bars diameter.

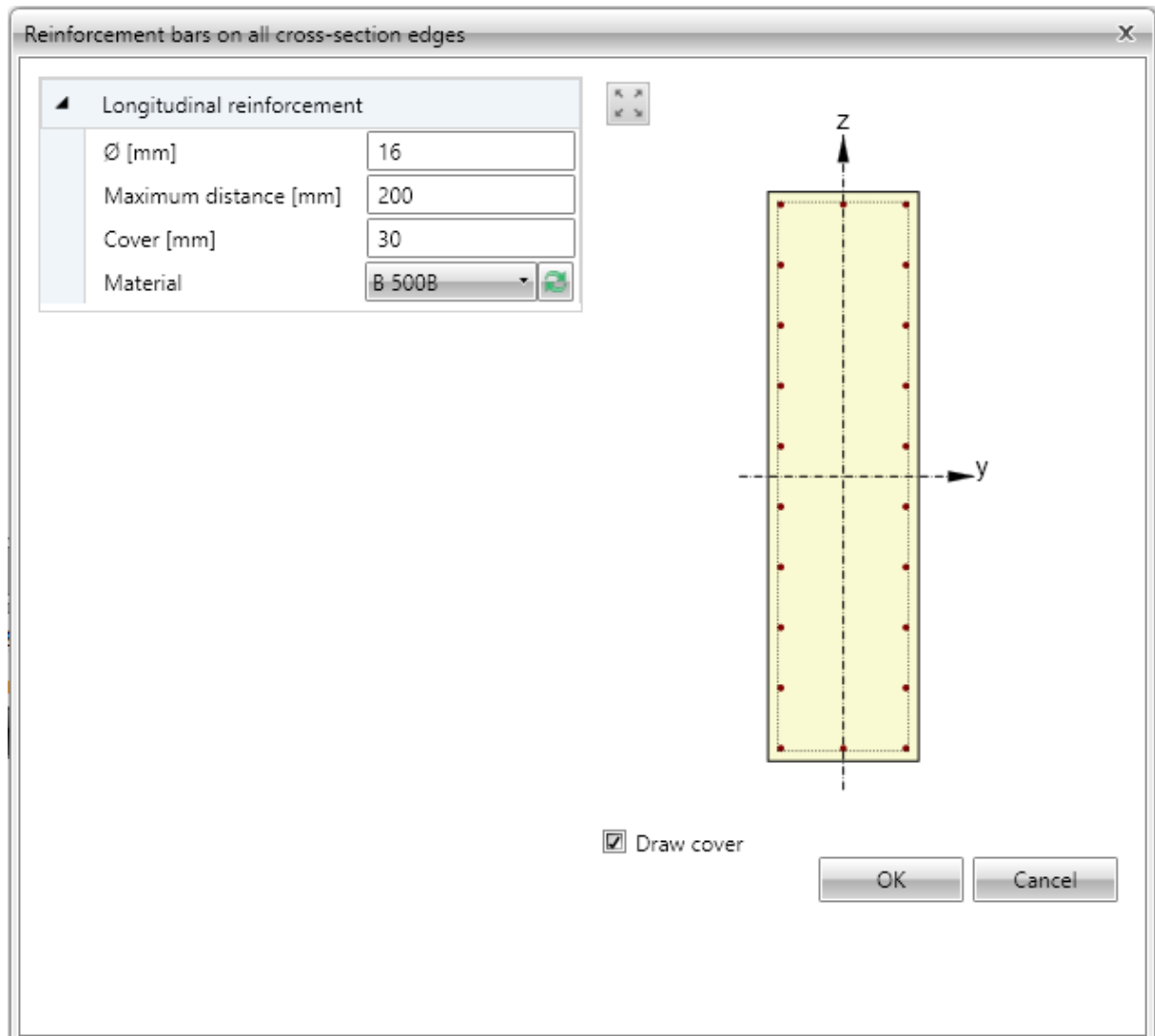

Individual dialog options:

- **Ø** – input diameter of bar in layers.
- **Maximal distance** – input the maximal distance between bars to determine the number of bars on edge.
- **Cover** – input the value of concrete cover, common for all edges.
- **Material** – in the list of available materials select material of bars in reinforcement layer or click edit button to edit material properties.
- **Draw cover** – switch on/off drawing of concrete cover.

Properties of individual bars of selected layer are displayed on tab **Bars** - see [Layer details](#).

12.2.6.4 Layer of reinforcement to wave of trapezoidal sheet

To input new layers of reinforcement of one-way slab defined by spacing click **Longitudinal bars > New by spacing** in ribbon group **Reinforcement** or click **New by spacing** above the table **Longitudinal reinforcement**.

Layer	Bars
Layer details	
∅ [mm]	10
n	4
Number of bars in wave	1
Concrete cover [mm]	10

Properties group **Layer details**:

- **∅** – input diameter of bar in layers.
- **n** – the calculated number of bars per meter in layer is displayed.
- **Number of bars in wave** – input number of bars in each wave of cross-section.
- **Cover** – input the value of concrete cover.

Properties of individual bars of selected layer are displayed on tab **Bars** - see [Layer details](#).

12.2.6.5 Layer of reinforcement by spacing

To input new layers of reinforcement of one-way slab defined by spacing click **Longitudinal bars > New by spacing** in ribbon group **Reinforcement** or click **New by spacing** above the table **Longitudinal reinforcement**.

Layer	Bars
Layer details	
∅ [mm]	10
Distance [mm]	200
n [-]	5,00
Edge bar specification	User input
Edge bars distance [mm]	100
Surface to cover	Lower
Cover [mm]	20

Layer is defined by face, distance between bars, distance of edge bar and concrete cover.

Properties group **Layer details**:

- **∅** – input the diameter of bar in the layer.
- **Distance** – input the distance between axes of adjacent bars.
- **n** – the calculated number of bars per meter in layer is displayed.
- **Edge bar specification** – select the mode to determine the position of the edge bar. One of following modes can be selected:
 - **Symmetrically** – the distance of the first bar from the edge is calculated in such way, that the distances of both edge bars from the edges is the same.

- **Diameter/2** – the distance of first bar from the edge is set as a half of the bar diameter.
- **User input** – the required value of the edge bar distance can be defined.
 - **Edge bar distance** – input the required value of the edge bar distance (or the calculated value is displayed).
- **Surface to cover** – select the face, to which the layer is defined.
- **Cover** – input the value of concrete cover.

Properties of individual bars of selected layer are displayed on tab **Bars** - see [Layer details](#).

12.2.7 User settings of reinforced cross-section

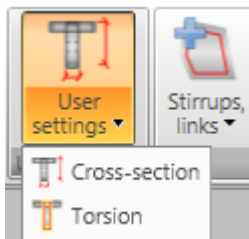

Ribbon group **User setting** contains commands to modify some shear and torsion calculation parameters of reinforced cross-section:

- **Set for shear** – input of user defined dimensions of effective cross-section for shear check.
- **Set for torsion** – input or modification of equivalent thin-shaped cross-section for check of torsion.

12.2.7.1 Input of effective cross-section for shear

If necessary, automatically determined values of effective cross-section for shear check can be modified by user defined values.

To input dimensions of effective cross-section for shear click **Set for shear** in ribbon group **User settings**.

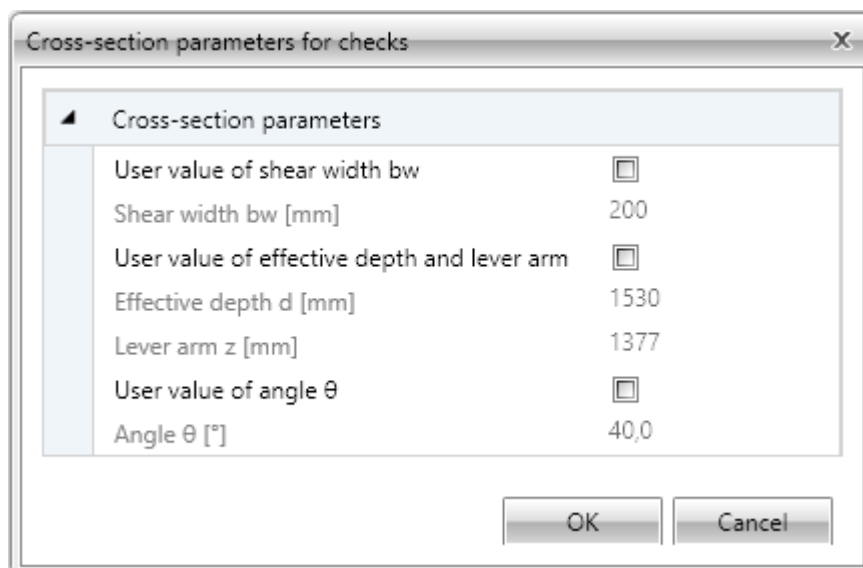

Calculated values of effective cross-section dimensions and overridable values of shear check from code and calculation settings are displayed in dialog. To enable input of user defined values check particular checkbox in first column.

12.2.7.2 Input of equivalent cross-section for torsion

Equivalent thin-walled section is used for calculation of torsion. Equivalent cross-section can be calculated using:

- stirrups which are marked as effective for torsion
- area and perimeter of real cross-section
- user defined values of cross-sectional area and perimeter.

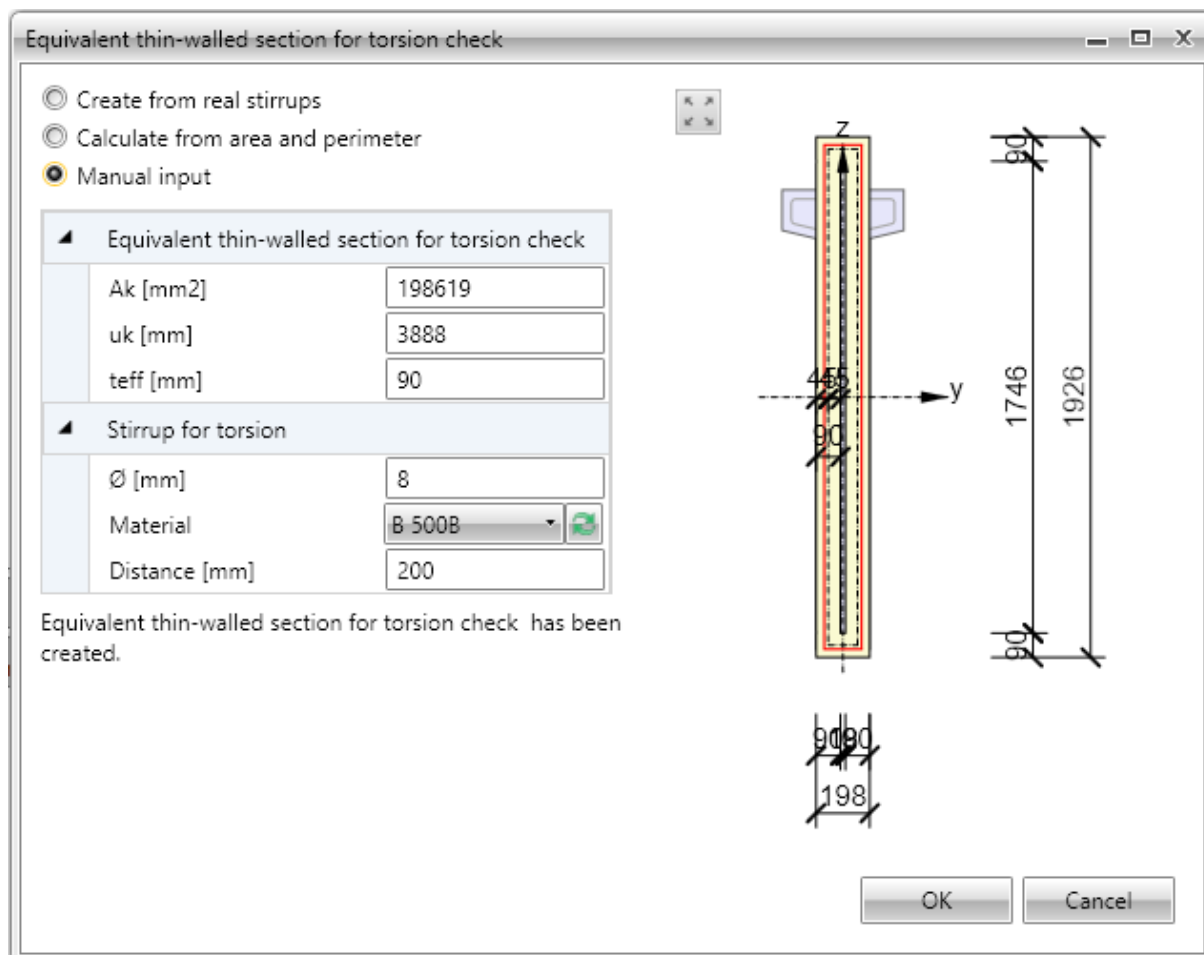

Particular options of dialog:

- **Create from real stirrups** – create equivalent thin-walled cross-section using outlines of stirrups, which are marked as effective for torsion. If this option is active, it is possible to click **Start stirrup shape definition** and adapt shape of stirrups for check of torsion.
 - **Start stirrup shape definition** – displays dialog, where shape of stirrup for determination of equivalent cross-section can be edited. Input of shape is done similarly to input of new stirrup shape using cross-section vertices
 - **Default stirrup shape** – restores shape of stirrup, which was defined as effective for torsion.
- **Calculate from area and perimeter** – calculate equivalent thin-walled cross-section using area and perimeter of original cross-section. Diameter, material and stirrups distance are taken from first stirrup, which is marked as effective for torsion.
- **Manual input** – values of area, perimeter and thickness of equivalent thin-walled cross-section including diameter, material and distance of stirrups are specified by user.

12.2.8 Deleting reinforcement



Use commands in ribbon group **Delete** to delete reinforcement from cross-section:

- **Selected** – delete selected layer or bar of reinforcement.
- **All** – delete all reinforcement.

12.2.9 Import and export of reinforced cross-section

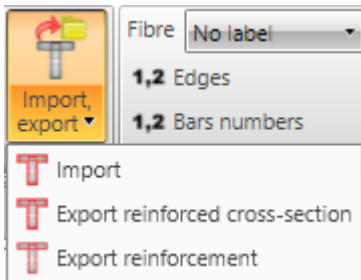

Drop-down button **Import, export** in ribbon group **Reinforcement** collects commands for import and export of reinforced cross-section:

- **Import** – starts import of cross-section shape including reinforcement from text file.
- **Export reinforced cross-section** – starts export of reinforced cross-section to file.
- **Export reinforcement** – starts export of reinforcement to file.

12.2.10 View settings of reinforced cross-section

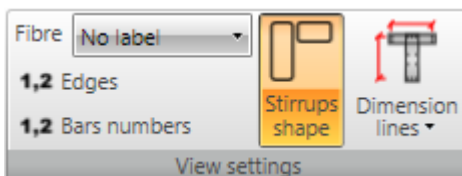

Ribbon group **View settings** can be used to set drawing options of reinforced cross-section:

- **Fibre** – select mode of fibres drawing in the list. One of following modes can be chosen:
 - **No labels** – description of fibres is not drawn.
 - **Outside** – fibre numbers are drawn outside the cross-section outline.
 - **Inside** – fibre numbers are drawn inside the cross-section outline.
- **Edges** – switch on/off drawing of numbers of edges.
- **Bar numbers** – turns on/off drawing of reinforcement bar numbers.
- **Stirrups shape** – turn on/off drawing of dimensioned stirrups outside the cross-section.
- **Dimension lines** – switch on/off drawing of dimension lines:
 - **Standard** – switch to drawing of standard dimension lines of reinforcement.
 - **Stationing** – switch to drawing of dimension lines with distances related to reference point.

12.3 2D members reinforcement

Commands for 2D reinforcement operations are collected in ribbon group **Reinforcement**.



Commands in ribbon group **Reinforcement**:

- **Reinforcement templates** – input cross-section reinforcement using predefined reinforcement template – see [Input of 2D members reinforcement by a template](#).
- **User templates** – input cross-section reinforcement using user defined templates of reinforcement – see [User defined reinforcement templates](#).
- **Delete** – see [Deleting reinforcement](#).

12.3.1 Input of 2D members reinforcement by a template

The basic reinforcement templates are available for sections of 2D members.

Bars diameter, angle between layers and the number of bars in the layers can be defined in the dialog for reinforcement input to reinforced cross-sections of 2D members:

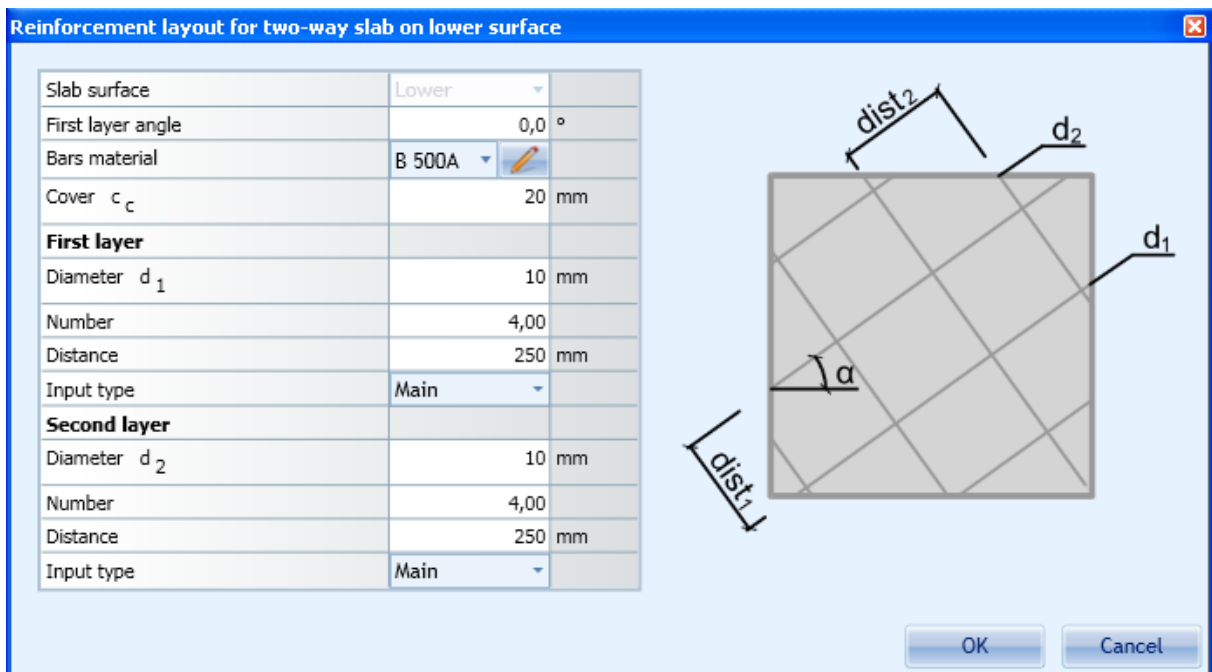

12.3.2 Input of new bars for 2D member cross-sections



To input layer of longitudinal reinforcement into member 2D cross-section click **New** in ribbon group **Longitudinal reinforcement**.

The reinforcement is defined in layers. The layer is defined by parameters. Some of the parameters are related. It means that changing one of them influences the other(s).

∅ [mm]	Number [/m]	Distance [mm]	Edge bar specification Edge bar distance [mm]	Angle [°] As [mm ² /m]	Surface / plane	Type of input	Value [mm] Eccentricity [mm]	Type	Material
12	6	167	Distance / 2 84	0.0 471	Lower	By clear cover	20 -74	Vertical	B 500B
12	6	167	Distance / 2 84	90.0 679	Upper	By clear cover	32 62	Vertical	B 500B

Parameters of one layer:

- \emptyset – input value of bar diameter for all bars in a layer
- **Number /m** - value defines the number of bars per meter in a layer. Value is recalculated after the distance between bars changes.
- **Distance** – input value of distance between bars. Value is recalculated after the number of bars changes.
- **Edge bar specification** – defines the type of calculation of the distance between the edge bars from the slab section edge. One of following modes can be selected:
 - **Symmetrically** – the distance of the first bar from the edge is calculated in such way, that the distances of both edge bars from the edges is the same.
 - **Diameter/2** – the distance of first bar from the edge is set as a half of the bar diameter.
 - **User input** – the required value of the edge bar distance can be defined.
- **Edge bar distance** –calculated value of the edge bar from slab edge. If the Edge bar specification is set to User input, the value is editable.
- **Angle** –direction of the reinforcement bars
- **As** – calculated reinforcement area

- **Surface/plane** – the surface selection for the definition of reinforcement. It can be the upper, lower or centroidal plane
- **Type of input** – select the mode for definition of the layer position in relation to the slab surface.
 - For the first layer at upper or lower surface following options are available:
 - **By clear cover** – a value entered in the column **Value** defines the distance between the bar's exterior surface and the slab surface.
 - **By axial cover** - a value entered in the column **Value** defines the distance between the bar axis and the slab surface.
 - For the second layer at upper or lower surface additional options are available:
 - **By clear distance from previous** – a value entered in the column **Value** defines the distance between two bar surfaces.
 - **By axial distance from previous** - a value entered in the column **Value** defines the distance between two bar axes.
 - For the centroidal layer following options are available:
 - **Eccentricity** – a value entered in the column **Value** defines the bar axis distance from the centroidal slab plane.
- **Eccentricity** – the calculated value of the bar axis distance from the centroidal slab plane
- **Type** – setting for the reinforcement type. Available options:
 - **Main**
 - **Distribution** – the distribution bars are taken into account only in detailing checks
- **Material** – select reinforcement steel material grade defined for the layer
-  - add new reinforcement layer into the table
-  - delete reinforcement layer from table

- **Import bars** – click to import bar coordinates from a text file – see [Format of text files for import and export](#).

12.3.3 Editing 2D members longitudinal reinforcement

Reinforcement layers										Identical properties for all bars			
Layer	n [1/m]	Distance [mm]	Type first bar position	First bar position [mm]	Angle [°]	As [mm ²]	Surface for cover	Position type	Value [mm]	Type	Ø [mm]	Identical	Value
1	5.99	167	Distance / 2	84	0.0	677	Lower	By clear cover	20	Vertical		<input checked="" type="checkbox"/>	12
2	5.99	167	Distance / 2	84	90.0	677	Upper	By clear cover	32	Vertical		<input checked="" type="checkbox"/>	B 500B

Layer details				
Bar	Ø [mm]	Material	Y [mm]	Z [mm]
6	12	B 500B	-334	62
7	12	B 500B	-167	62
8	12	B 500B	0	62
9	12	B 500B	167	62
10	12	B 500B	334	62

According to the selected 2D member's longitudinal reinforcement type, the following properties can be adjusted in Data window:

- Number of bars per meter
- Distance between bars
- Edge bar specification
- Edge bar distance
- Angle of bar direction
- Area of reinforcement
- Value – bar surface distance from slab surface
- Type of reinforcement

If proper checkboxes **Identical** are selected in table **Identical properties for all bars**, diameter or material of reinforcement bar can be changed in this table. If checkboxes are not selected, diameter or material can be edited in table **Reinforcement layers**.

The same rules for input and recalculation of values, which are used when defining new reinforcement, are applied when editing the 2D reinforcement layers.

12.3.4 Shear reinforcement of 2D members

12.3.4.1 Ribbon group Links



Use commands in ribbon group Links to define shear reinforcement in one-way slabs:

- **New** – add new links into the cross-section.

12.3.4.2 New links

Click **New** in ribbon group **Links** to add new links into the cross-section.

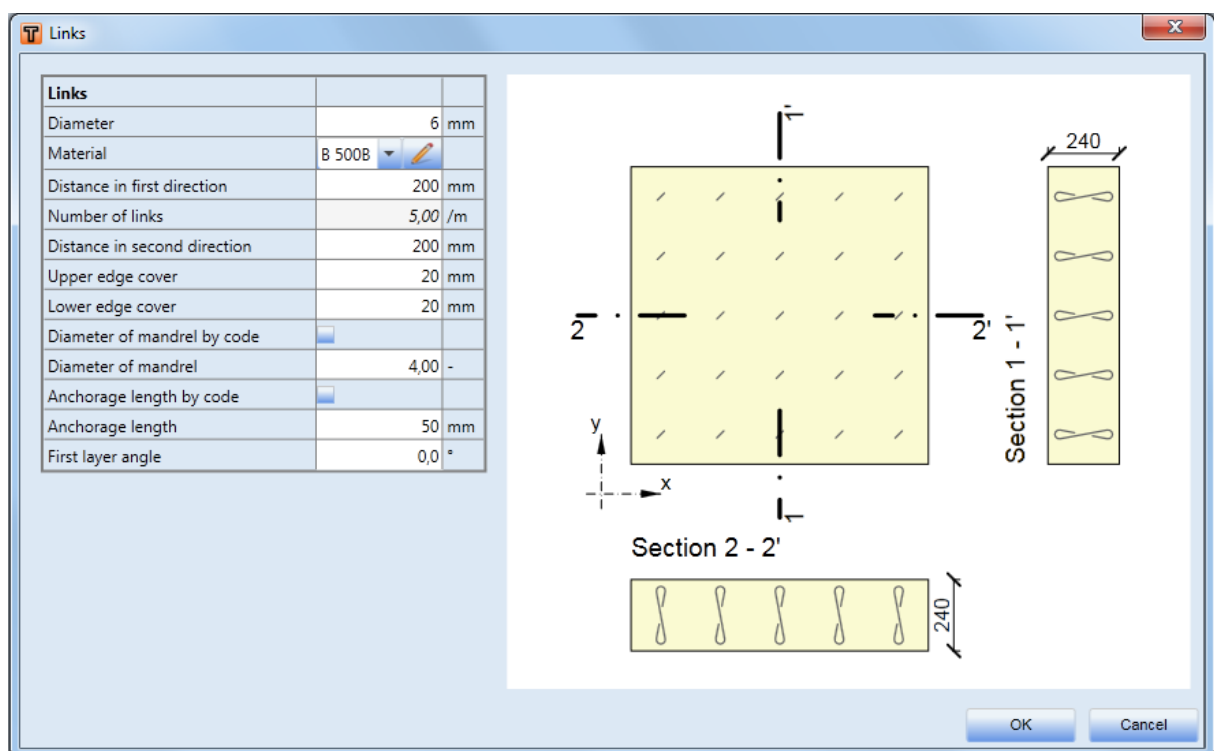

Options of **Links** dialog:

- **Diameter** – input diameter of link bar.
- **Material** – select material of link bar.
- **Distance in first direction** – input the distance between axes of links in first direction of the cross-section (x-axis).
- **Number of links** – the calculated number of links per meter is displayed.
- **Distance in second direction** – input the distance between axes of links in second direction of the cross-section (y-axis).
- **Upper edge cover** – input the value of concrete cover at the top edge of the cross-section.
- **Lower edge cover** – input the value of concrete cover at the lower edge of the cross-section.

- **Diameter of mandrel by code** – if the checkbox is selected, the mandrel diameter is calculated automatically according to the national code rules. Otherwise, the requested value of mandrel diameter can be defined.
- **Diameter of mandrel** – input the requested value of mandrel as multiple of link bar diameter.
- **Anchorage length by code** – if the checkbox is selected, the anchorage length of link is calculated automatically according to the national code rules. Otherwise, the requested value of anchorage length can be defined.
- **Anchorage length** – input the requested value of anchorage length.
- **First layer angle** – input the angle between rows of links and the first direction of the cross-section (x-axis).

12.3.4.3 Editing links

The properties of the selected link can be edited in the data window.

Layers of links										
Link	Ø [mm]	Distance x [mm]	Distance y [mm]	Angle [°]	A s [mm ² /m ²]	Upper cover [mm]	Lower cover [mm]	n dm [-]	Anchorage length [mm]	Material
1	6	200	200	0,0	707	20	20	4,00	50	B 500B 

Diameter, distance between links in the first cross-section direction, distance between links in the second cross-section direction, angle of link rows, upper cover, lower cover, mandrel diameter, anchorage length and material of the links layer can be edited in the **Layers of links** table.

12.4 User defined reinforcement templates

See [User defined reinforcement templates](#).

12.5 Deleting reinforcement

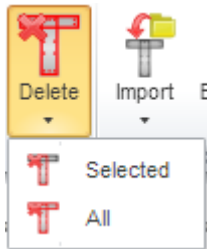

Use commands of drop-down button **Delete** in ribbon group **Reinforcement** to delete reinforcement from cross-section:

- **Selected** – delete selected layer or bar of reinforcement.
- **All** – delete all reinforcement.

12.6 Import of reinforced cross-section

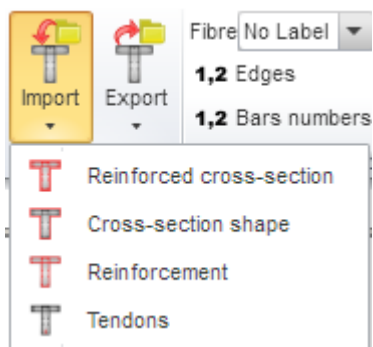

If IDEA RCS is started from superior application, some options of import may not be available.

Commands for import of reinforced cross-section (geometry, reinforcement) from text file (format *.NAV) are collected in drop-down button **Import** in ribbon group **Import, export**- see [Format of text files for import and export](#):

- **Reinforced cross-section** – start import of cross-section shape including reinforcement from text file.
- **Cross-section shape** – start import of cross-section shape from text file.
- **Reinforcement** – start import of reinforcement from text file.
- **Tendons** – start import of tendons from text file.

12.7 Export of reinforced cross-section

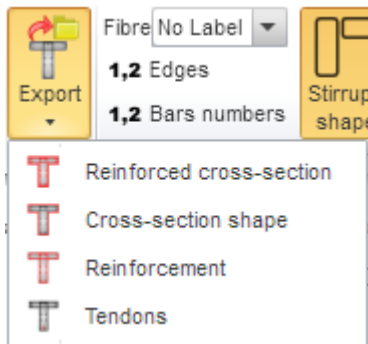

Commands for export of reinforced cross-section (geometry, reinforcement) to text file (format *.NAV) are collected in drop-down button group **Export** in ribbon group **Import, export**:

- **Reinforced cross-section** – exports the cross-section including the reinforcement to a file (format *.NAV).
- **Cross-section shape** – exports only the cross-section without the reinforcement to a file (format *.NAV).
- **Reinforcement** – exports only the reinforcement to a file (format *.NAV).
- **Tendons** – exports only tendons to a file (format *.NAV)

12.8 View settings of reinforced cross-section

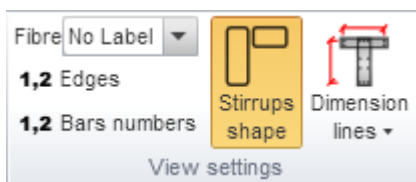

Ribbon group **View settings** can be used to set drawing options of reinforced cross-section:

- **Fibre** – select mode of fibres drawing in the list. One of following modes can be chosen:
 - **No labels** – description of fibres is not drawn.
 - **Outside** – fibre numbers are drawn outside the cross-section outline.
 - **Inside** – fibre numbers are drawn inside the cross-section outline.
- **Edges** – switch on/off drawing of numbers of edges.
- **Bar numbers** – turns on/off drawing of reinforcement bar numbers.
- **Stirrups shape** – turn on/off drawing of dimensioned stirrups outside the cross-section.
- **Dimension lines** – switch on/off drawing of dimension lines:
 - **Standard** – switch to drawing of standard dimension lines of reinforcement.
 - **Stationing** – switch to drawing of dimension lines with distances related to reference point.

13 Check results

The checks and evaluation of results are launched using navigator commands **Current Section & Extreme > Results**. There is a separate tab for each check type in the Data window.

The cross-section check has a graphical and textual representation. Graphically, the presented results are drawn in the Main dialog window. Results in textual presentation are displayed in the Data window. For the checks, whose graphical presentation is not useful, a picture of reinforced cross-section with overall dimensions and reinforcement data is displayed in the Main window.

The graphical presentation of checks is adjustable by a setting dialog. The setting is saved for the check and later used when the picture is printed into report.

13.1 Setting of check execution of 1D members

For the current section, click navigator command **Current Section & Extreme > Calculation control** to launch the dialog to select checks, which will be performed in the current section.

Capacity N-M-M	<input checked="" type="checkbox"/>
Shear	<input checked="" type="checkbox"/>
Torsion	<input checked="" type="checkbox"/>
Interaction	<input checked="" type="checkbox"/>
Fatigue	<input checked="" type="checkbox"/>
Stress limitation	<input checked="" type="checkbox"/>
Crack width	<input checked="" type="checkbox"/>
Flexural slenderness	<input checked="" type="checkbox"/>
Detailing	<input checked="" type="checkbox"/>
Response N-M-M	<input type="checkbox"/>
Stiffnesses	<input type="checkbox"/>
M-N-k diagram	<input type="checkbox"/>

Only selected checks are executed. Not selected checks are not calculated and the results are empty. Thus they can't be printed into a report.

- **Capacity N-M-M** – switch on/off the execution of the capacity check.
- **Shear** – switch on/off the execution of the shear check.
- **Torsion** – switch on/off the execution of the torsion check.
- **Interaction** – switch on/off the execution of the check of interaction of normal force, shear force and bending moment.
- **Fatigue** – switch on/off the execution of the fatigue check. This combo box is available only if the fatigue check is switched on in the Project data dialog.
- **Stress limitation** – switch on/off the execution of the stress limitation check.
- **Crack width** – switch on/off the execution of the crack width check.
- **Brittle failure** – switch on/off the execution of the brittle failure check. This combo box is available only for prestressed sections and if the code EN 1992-2 is switched on in the Project data dialog.
- **Detailing** – switch on/off the execution of the detailing check.

- **Response N-M-M** – switch on/off the execution of the response check.
- **Stiffnesses** – switch on/off the calculation of the stiffnesses of the cross-section.
- **M-N- κ diagram** - switch on/off the calculation of the M-N- κ diagrams.
- **Unselect all** – unselect all selected checks.
- **Select all** – select all checks.

13.2 Setting of check execution of 2D members

Capacity N-M	<input checked="" type="checkbox"/>
Shear	<input type="checkbox"/>
Interaction	<input checked="" type="checkbox"/>
Fatigue	<input type="checkbox"/>
Stress limitation	<input checked="" type="checkbox"/>
Crack width	<input checked="" type="checkbox"/>
Detailing	<input checked="" type="checkbox"/>
Response N-M	<input checked="" type="checkbox"/>

For 2D member sections the following checks are available:

- **Capacity N-M** - switch on/off the execution of the capacity check.
- **Shear** - switch on/off the execution of the shear check.
- **Interaction** - switch on/off the execution of the check of interaction of normal force, shear force and bending moment.
- **Fatigue** - switch on/off the execution of the fatigue check. This combo box is available only if the fatigue check is switched on in the Project data dialog.
- **Stress limitation** - switch on/off the execution of the stress limitation check.
- **Crack width** - switch on/off the execution of the crack width check.
- **Detailing** - switch on/off the execution of the detailing check.
- **Response N-M** - switch on/off the execution of the response check.
- **Unselect all** - unselect all selected checks.
- **Select all** – select all checks.

13.3 Setting the evaluated combination

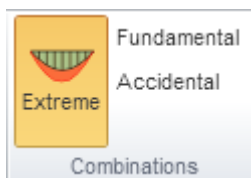

If the accidental combination is defined and switched on to be used in checks, the evaluation mode of combinations can be set in appropriate checks.

- **Extreme** – switch to evaluate the extreme check values from the fundamental and the accidental combination..
- **Fundamental** – switch to evaluate results for the fundamental combination only.
- **Accidental** – switch to evaluate results for the accidental combination only.

The extreme results are searched when evaluating results of overall checks or when generating the check report.

13.4 Calculation mode settings

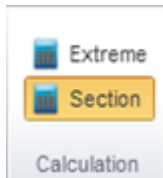

When evaluating check results, calculation mode can be set in ribbon group **Calculation** to specify the range of performed recalculations, e.g. after changing national code settings:

- **Extreme** – switch to calculate results only for the current load extreme of the current section.
- **Section** – switch to calculate results for all extremes of the current sections.

13.5 Setting of the checked direction for 2D members section check

The checks are executed in the directions of the principal stresses or user defined directions (see [2D Section internal forces](#)).

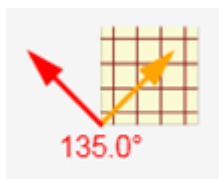

In the presented checks (graphical and numerical presentation) it is possible to switch between particular directions in which the results of checks are evaluated. In the graphical window an arrow mark is schematically drawn to display the available directions. Clicking the mark the screen switches to another direction.

Available arrows are coloured by

- **Red** - for actual direction
- **Orange** – for direction of the extreme check
- **Blue** – other available directions



Click buttons in ribbon group **Checked directions** to switch between directions. Results for previously/or next checked direction are displayed afterwards.

In the Report, the extreme check is always printed.

13.6 Overall check

To display the overview of results for all executed checks in the current section and the current loads extreme click navigator command **Results** and tab **Overall** in the Data window. In the graphical window the reinforced cross-section with information about longitudinal and shear reinforcement is displayed.

Ribbon groups **Components label** and **Calculation** are available.

The overview of all check results is displayed in the Data window. The check with the maximal value is labeled as Governing type of check.

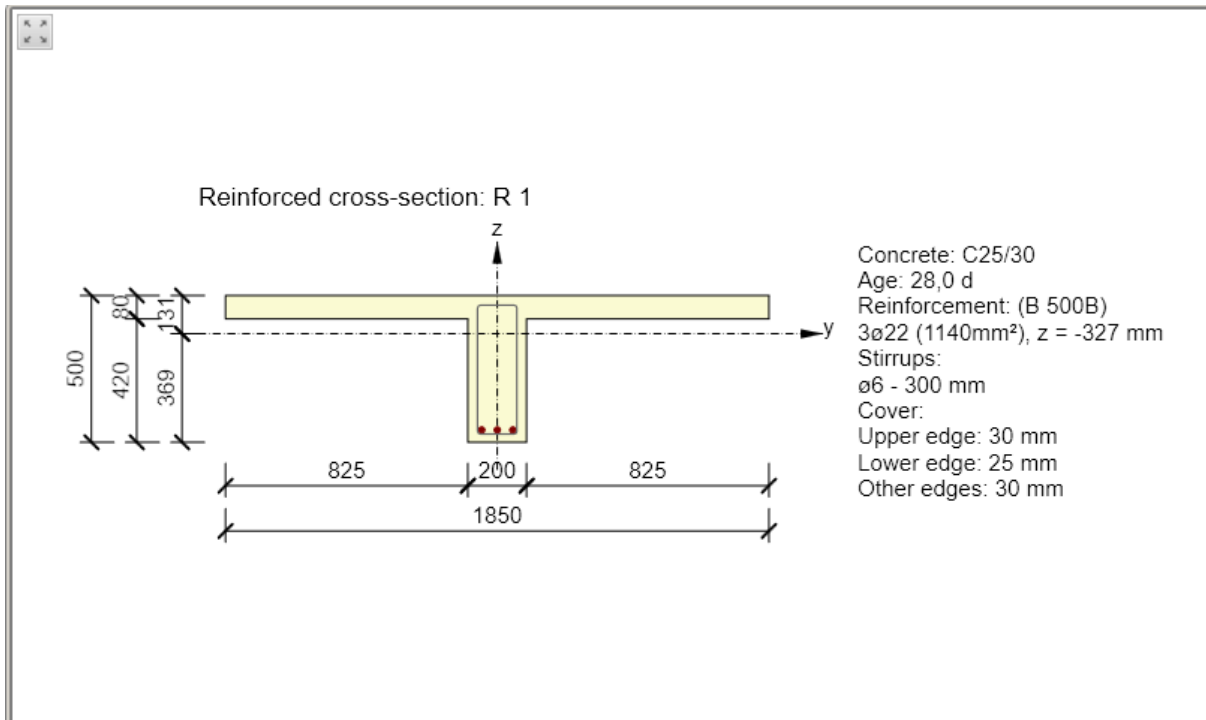

Data

Overall Shear Torsion Interaction Stress Limitation Crack Width Flexural Slenderness Response N-M-M Stiffnesses

Overall

Governing type of check	N_{Ed} [kN]	$M_{Ed,y}$ [kNm]	$M_{Ed,z}$ [kNm]	V_{Ed} [kN]	T_{Ed} [kNm]	Value [%]	Check
Torsion					0,0	0,0	OK
Type of check	N_{Ed} [kN]	$M_{Ed,y}$ [kNm]	$M_{Ed,z}$ [kNm]	V_{Ed} [kN]	T_{Ed} [kNm]	Value [%]	Check
Shear	0,0			0,0	0,0	0,0	OK
Torsion					0,0	0,0	OK
Interaction	0,0	214,9	0,0	0,0	0,0	0,0	OK
Stress Limitation	0,0	0,0	0,0			0,0	OK
Crack Width	0,0	0,0	0,0			0,0	OK
Flexural slenderness	0,0	0,0	0,0			0,0	OK

Limit value of the exploitation of the cross-section: 100,0 %

13.6.1 Ribbon group Component labels

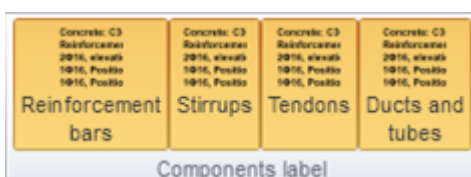

- **Reinforcement bars** – show or hide longitudinal reinforcement description in the picture of reinforced cross-section
- **Stirrups** – show or hide stirrups description in the picture of reinforced cross-section
- **Tendons** – show or hide tendons description in the picture of reinforced cross-section
- **Ducts and tubes** – show or hide description of tendon ducts and debonding tubes in the picture of reinforced cross-section.

13.6.2 Ribbon group Calculation

See Calculation mode settings.

13.7 Section Capacity check

To display resulting interaction diagrams for the current section and the current loads extreme click navigator command **Results** and tab **Capacity N-M-N** in the Data window.

Ribbon groups **Type of results**, **Combinations**, **Checked directions**, **Diagram type**, **Interaction surface section**, **Calculation** and **Code and calculation settings** are available.

If **Type of result** is set to **Extreme**, ribbon groups **Draw points**, **Grid of interaction surface section** and **Interaction diagram export** are available.

If **Type of result** is set to **Section**, ribbon groups **Colors settings** and **Drawing setting** are available.

In the Main window the interaction diagrams are drawn. In the Data window the text representation is printed.

Either one interaction diagram may be drawn for the current extreme of the current section or all interaction diagrams for all extremes in the current section may be drawn.

Interaction diagram is calculated with respecting effects of prestressing. Thus design values of internal forces without prestressing are used for capacity check.

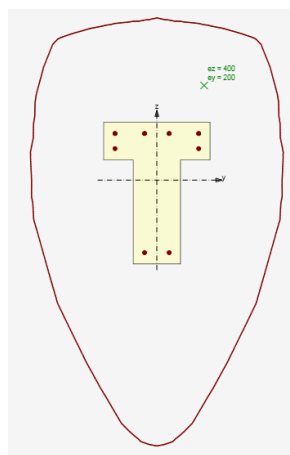
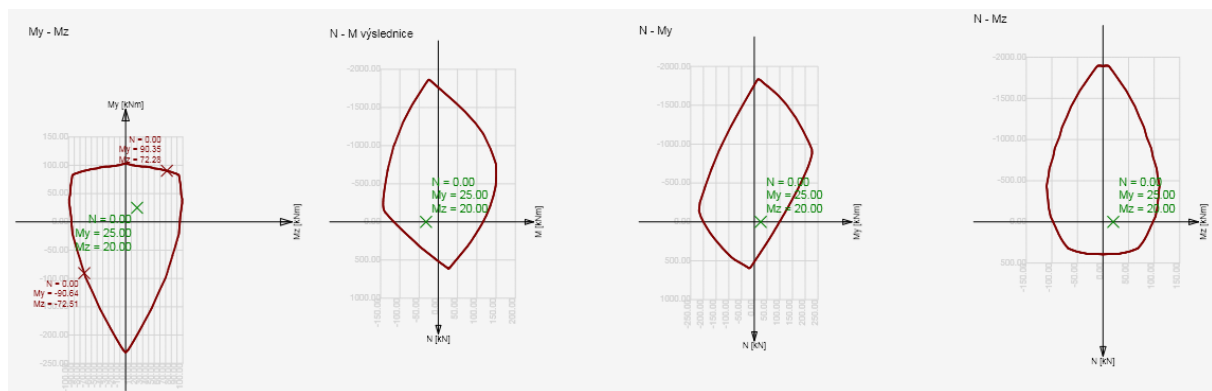

13.7.1 Ribbon group Type of results

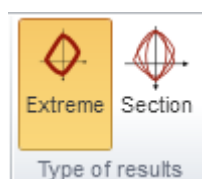

Use commands in this ribbon group to switch the modes of interaction diagrams drawing.

- **Extreme** – switch to draw one interaction diagram for the current extreme of the current section.
- **Section**– switch to draw interaction diagrams for all extremes of the current section.

13.7.2 Ribbon group Combinations

See [Setting the evaluated combination](#).

13.7.3 Ribbon group Checked directions

See [Setting of the checked direction for 2D members section checks](#).

13.7.4 Ribbon group Diagram type

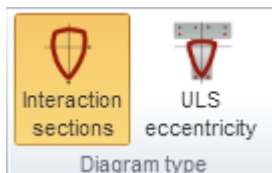

- **Interaction sections** - switch to draw the individual sections of the interaction surface.
- **ULS eccentricity** - switch to draw the interaction diagram recalculated to the eccentricity of normal force. (the core of the cross-section). In case that the normal force is zero, a horizontal section in My-Mz plane is drawn.

13.7.5 Ribbon group Interaction surface sections

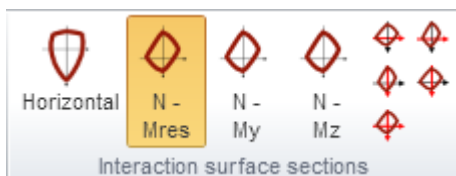

The buttons turn on/off drawings of interaction surface sections.

- **Horizontal** – turns on/off drawing of horizontal section of intersection surface through the point $N_{ed}, 0, 0$.
- **N-M res** – turns on/off drawing of the vertical section of intersection surface through the origin of coordinate system and the result of bending moments $ME_{d,y}, ME_{d,z}$. If the both sections are zero, the section is drawn in the plane N-My.
- **N – My** – turns on/off drawing of a vertical section of intersection surface through the point $(0,0,ME_{d,z})$ parallel with the plane N-My.
- **N–Mz** – turns on/off drawing of a vertical section of intersection surface through the point $(0,0,ME_{d,y})$ parallel with the plane N-Mz.

The buttons on the right side of the ribbon group are used for adjusting the vertical and horizontal scale of interaction diagram, or respectively for a setting of default scale in both directions.

13.7.6 Ribbon group Draw points

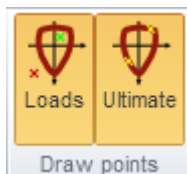

Buttons turn on/off the drawing of points representing loads in interaction diagram.

- **Loads** - turns on/off the drawing of points representing load effects, i.e. applied design internal forces.
- **Ultimate** – turns on/off drawing of points representing design resistance forces.

13.7.7 Ribbon group Grid of interaction surface sections

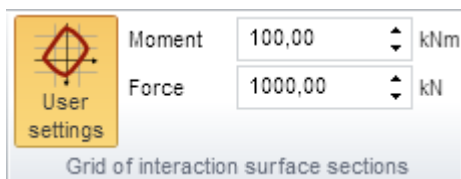

- **User settings** – switch on/off possibility to define user settings of grid distances of interaction surface section. If not selected, the grid setting is determined automatically.
- **Moment** – input step of moment in the grid of interaction surface section.
- **Force** – input step of moment in the grid of interaction surface section.

13.7.8 Ribbon group Export of interaction diagram

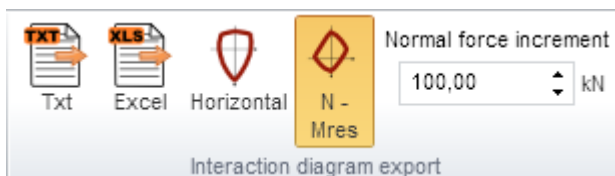

Interaction diagram can be exported to the text file or into the Microsoft Excel file.

To export the interaction diagram use commands in ribbon group Interaction diagram export:

- **TXT** – export of interaction diagram points to a text file
- **Excel** – export points of interaction diagram to the Microsoft Excel file.
- **Normal force increment** – value of normal force increment for export of interaction diagram points. The sections on the vertical axis of interaction diagram are generated (parallel to the horizontal axis) respecting the specified value of normal force increment. Intersection points of the section and the curve of interaction diagram are exported to the file.

13.7.9 Ribbon group Colors settings

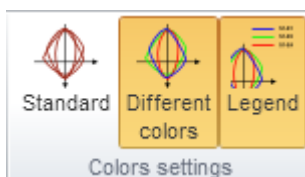

This group is available if **Type of results** is set to **Section**.

Use commands in this ribbon group to set the drawing colors of interaction diagrams..

- **Standard** – switch to draw all interaction diagrams in one color – default color for drawing of interaction diagrams.
- **Different colors** – switch to draw each interaction diagram in different color.
- **Legend** – switch on/off drawing of legend describing the points which represents the design resistance forces.

13.7.10 Ribbon group Drawing settings

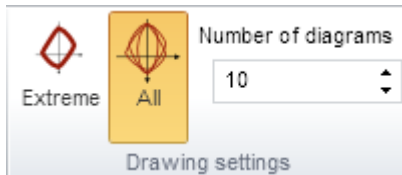

This group is available if **Type of results** is set to **Section**.

- **Extreme** – switch to draw the extremal interaction diagram in the current position.
- **All** – switch to draw all interaction diagrams in the current position.
- **Number** – set the number of interaction diagrams to be drawn. The diagrams with the highest exploitation values are drawn.
- **Position** – set the position on the current design member, for which the interaction diagrams are drawn.

13.7.11 Ribbon group Calculation

See **Calculation mode settings**.

13.7.12 Ribbon group Code and calculation settings

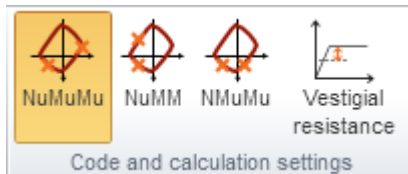

Some options of **Code and calculation settings** dialog are directly available in this ribbon group:

- **NuMuMu** - cross-sectional resistance is determined assuming proportional change of all components of acting internal forces (the eccentricity of normal force remains constant) until interaction surface is reached.
- **NuMM** - cross-sectional resistance is determined assuming constant bending moments (equal to currently acting design moments) and gradual change of normal force until interaction surface is reached.
- **NMuMu** - cross-sectional resistance is determined assuming constant normal force (equal to currently acting design normal force) and proportional change of both bending moments until interaction surface is reached.
- **Vestigial resistance** – switch on/off calculation of vestigial resistance of cross-section.

13.8 Shear check

To display results of the shear check for the current section and the current loads extreme click navigator command **Results** and tab **Shear** in the Data window.

In the Main graphical window the reinforced cross-section is displayed with the geometrical, material and overall data about the shear and longitudinal reinforcement. The check itself doesn't have any graphical representation.

In the Data window the detailed text representation of shear check is printed.

Ribbon groups **Combinations**, **Code and calculation settings**, **Resistance region** and **Calculation** are available.

13.8.1 Ribbon group Combinations

See [Setting the evaluated combination](#).

13.8.2 Ribbon group Code and calculation settings

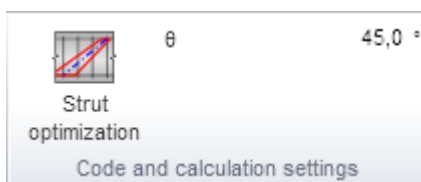

- **Strut optimisation** - switch on/off performing the optimisation of concrete strut during check to achieve the optimal utilisation of truss analogy component selected in the code and calculation settings. If the option is selected, the calculated strut angle is displayed. Otherwise the user defined value of strut angle can be defined.

13.8.3 Ribbon group Resistance area

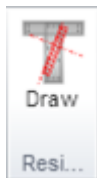

- **Draw** – switch on/off drawing of shear resistance area. For rectangular and T-sections only.

13.8.4 Ribbon group Calculation

See [Calculation mode settings](#).

13.9 Torsion check

To display results of the torsion check for the current section and the current loads extreme click navigator command **Results** and tab **Torsion** in the Data window.

In the Main graphical window the picture of reinforced cross-section and the picture of equivalent thin-walled cross-section are drawn. The check itself doesn't have any graphical representation.

Ribbon groups **Combination**, **Code and calculation settings** and **Calculation** are available.

In the Data window a detailed text representation of the torsion check is printed.

13.9.1 Ribbon group Combinations

See [Setting the evaluated combination](#).

13.9.2 Ribbon group Code and calculation settings

See [Ribbon group Code and calculation settings](#).

13.9.3 Ribbon group Calculation

See [Calculation mode settings](#).

13.10 Interaction check of shear, torsion, bending and normal force

To display results of the response check with the interaction of shear, torsion, bending and normal force for the current section and the current loads extreme click navigator command **Results** and tab **Interaction** in the Data window.

In the Main graphical window the check is drawn, in the Data window the detailed text representation of the check is printed.

Ribbon groups **Combinations**, **Code and calculation settings**, **View**, **View setting**, **Checked directions**, **Strain**, **Stress**, **Results label**, **Results graph**, **Resultant forces**, **Cross-section**, **Type of results** and **Calculation** are available.

13.10.1 Ribbon group Combinations

See [Setting the evaluated combination](#).

13.10.2 Ribbon group Code and calculation settings

See [Ribbon group Code and calculation settings](#).

13.10.3 Ribbon group View

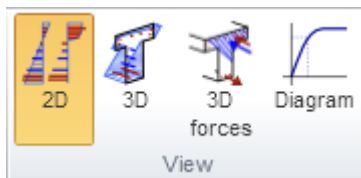

- **2D** – turns on drawing of results in 2D picture (cross-section areas, courses of stress and strain).
- **3D** – turns on drawing of courses of stress and strain of concrete and reinforcement in 3D view.
- **3D forces** – turns on drawing of forces resultants in 3D view.
- **Diagram** - turns on/off drawing of check results as Stress-strain diagrams, draws stress and strain in concrete fibres and reinforcement bars – see [Check by Stress-strain diagram](#).

13.10.4 Ribbon group View setting

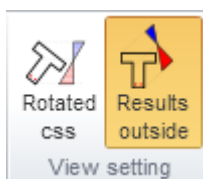

- **Rotated css** – turns on/off drawing of cross-section and stress and strain distributions on a rotated cross-section in the way that the neutral axis is horizontal to obtain a larger picture on the screen.
- **Results outside** - turns on/off drawing of a cross-section and stress and strain distributions outside the cross-section. If the stress and strain is drawn inside the cross-section, the strain and stress in concrete and in reinforcement is displayed. The stress in reinforcement bars is not displayed inside the cross-section

13.10.5 Ribbon group Checked directions

See [Setting of the checked direction for 2D members section checks](#).

13.10.6 Ribbon group Strain

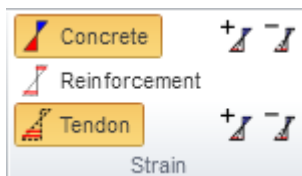

Set strain courses drawing options. Options for tendons are available only for staged sections.

- **Concrete** - turns on/off drawing of concrete strain distribution.
- **Reinforcement** – turns on/off drawing of strain in the reinforcement bars.
- **Tendon** – turns on/off drawing of strain in the tendons.
- + - increase the scale of strain display (the strain of concrete and reinforcement are in the same scale).
- -- - decrease the scale of strain display (the strain of concrete and reinforcement are in the same scale).
- + - increase the scale of tendon strain display.
- -- - decrease the scale of tendon strain display.

13.10.7 Ribbon group Stress



Set stress courses drawing options. Options for tendons are available only for staged sections.

- **Concrete** - turns on/off display of concrete stress distribution.
- **Reinforcement** - turns on/off display of stress in reinforcement bars.
- **Tendon** - turns on/off display of stress in tendons.
- + - increase the scale of concrete stress drawing (the stress of concrete and reinforcement bars are in different scale).
- -- - decrease the scale of concrete stress drawing
- + - increase the scale of stress drawing in the reinforcement bars.
- -- - decrease the scale of stress drawing in the reinforcement bars.
- + - increase the scale of stress drawing in the tendons.
- -- - decrease the scale of stress drawing in the tendons.

13.10.8 Ribbon group Results label

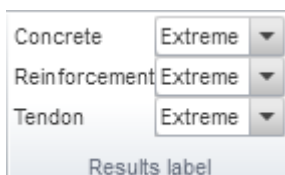

The group provides options for labelling style of results in concrete, reinforcement and tendons. Options for tendons are available only for staged sections.

- **Concrete** – choose labelling style for concrete:
 - **No label** – turns off all the labels.
 - **Extreme** – labels the minimum and maximum strain/stress values in concrete.
 - **All** – labels the strain/stress values in all concrete fibres.
- **Reinforcement** – choose labelling style of reinforcement bars results:
 - **No label** - turns off all the labels in the reinforcement bars.
 - **Extreme** - labels the minimum and maximum strain/stress values in the reinforcement bars.
 - **All** - labels the strain/stress values in all the reinforcement bars.
- **Tendon** – choose labelling style of tendon results:
 - **No label** - turns off all the labels in tendons.
 - **Extreme** - labels the minimum and maximum strain/stress values in tendons.
 - **All** - labels the strain/stress values in all tendons.

13.10.9 Ribbon group Results graph



The group provides options to display the courses of stress and strain in concrete, reinforcement and tendons. Options for tendons are available only for staged sections.

- **Concrete** – choose graph style of concrete results:
 - **Line** – draws the outline of the graph of stress and strain courses in concrete.
 - **Hatch** – draws hatched graph of stress and strain courses in concrete.
 - **Fill** – draws graph of stress and strain courses in concrete filled with colour.
- **Reinforcement** - choose graph style of results in reinforcement:
 - **Line** – draws the reinforcement bars in graph of stress and strain courses as lines.
 - **Outline** – draws the outline of reinforcement bars in graph of stress and strain courses.
 - **Fill** – draws the filled outline of reinforcement bars in graph of stress and strain courses.
- **Tendon** - choose graph style of results in tendons:
 - **Line** – draws the tendons in graph of stress and strain courses as lines.
 - **Outline** – draws the outline of tendons in graph of stress and strain courses.
 - **Fill** – draws the filled outline of tendons in graph of stress and strain courses.

13.10.10 Ribbon group Resultant forces

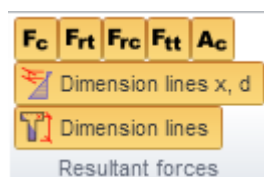

- **Fc** - shows/hides the position of the resultant of the concrete compression zone.
- **Frt** - shows/hides the position of the resultant of the tensile reinforcement.

- **Frc** - shows/hides the position of the resultant of the reinforcement in compression.
- **Ftt** - shows/hides the position of the resultant of the tendons.
- **Ac** - shows/hides the hatching of the concrete compression zone.
- **Dimension lines x, d** - shows/hides the dimension lines for the depth of the compression zone and the effective depth of cross-section.
- **Dimension lines of results positions** - shows/hides the dimension lines for the positions of resultant forces.

13.10.11 Ribbon group Cross-section

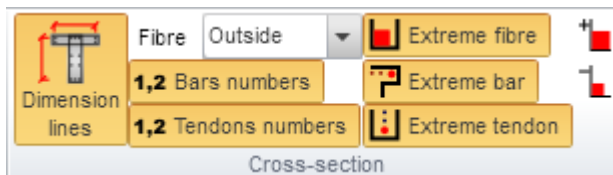

- **Dimension lines** - shows/hides the dimension lines for the cross-section geometry and the centre of gravity.
- **Fibre** – the list-box provides three options to draw the fibre labels:
 - **Outside** of the outline of the cross-section;
 - **Inside** of the outline of the cross-section;
 - **No label**.
- **Bars numbers** - shows/hides the bar numbers.
- **Tendons numbers** - shows/hides the tendon numbers.
- **Extreme fibre** - highlights the extremely loaded fibre (s).
- **Extreme bar** - highlights the extremely loaded reinforcement bar(s).
- **Extreme tendon** – highlights the extremely loaded tendon(s).
- **+** - increase concrete fibre and extreme reinforcement/tendons labels.
- **--** - decrease concrete fibre and extreme reinforcement/tendons labels .

Options for tendons are available only for staged sections.

13.10.12 Ribbon group Type of results

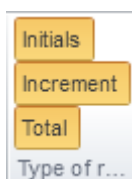

To set which graphs of stress-strain courses should be displayed, use buttons in ribbon group **Type of results**. This group is available only for staged sections.

- **Initials** – turns on/off drawing of courses of stress and strain caused by prestressing and permanent component of load effects.
- **Increment** – turns on/off drawing of courses of stress and strain caused by effects of variable loads in current loads extreme.
- **Total** – turns on/off drawing of courses of stress and strain caused by all effects (initials and variable loads) in current loads extreme.

Options for tendons are available only for staged sections.

13.10.13 Ribbon group Calculation

See **Calculation mode settings**.

13.10.14 Check by Stress-strain diagram

To launch the check using a stress/strain diagram click **Diagram** in ribbon group **Check**. This option displays the stress/strain of the concrete fibres and reinforcement bars in a stress/strain diagram.

In the displayed picture the concrete fibre or the reinforcement bar can be reviewed by double-clicking with the left mouse button. For this selected part the stress-strain diagram is displayed for steel or concrete elements with display of position of inserted member. Positioning the mouse over the reinforcement bar or the concrete fibre displays the information bubble with the numerical values for the inserted element.

Ribbon groups **Cross-section**, **Extremes labels** and **Stress-strain relationships** are available.

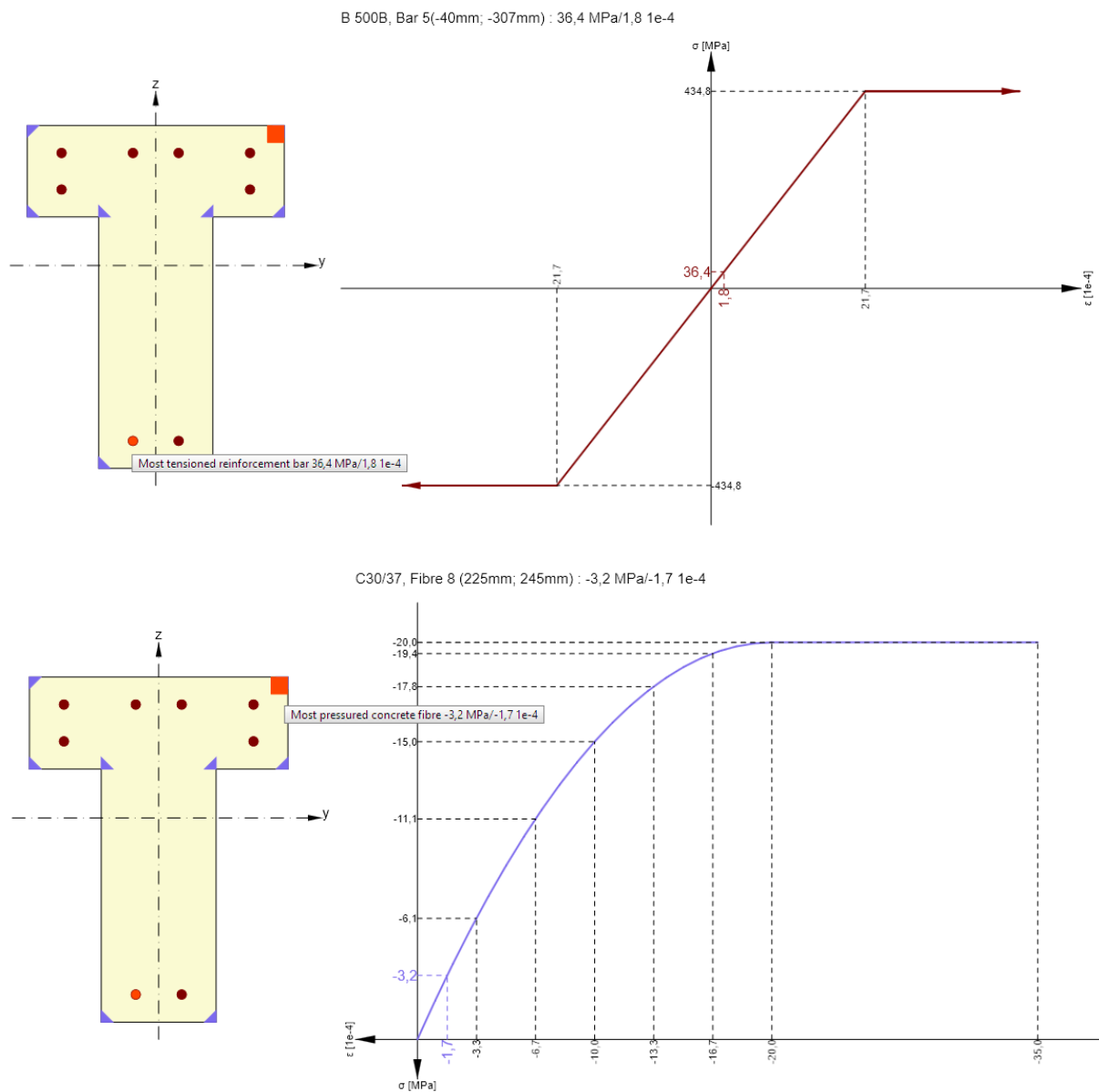

13.10.14.1 Ribbon group Cross-section

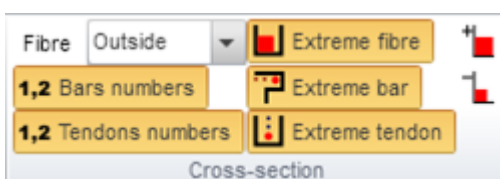

- **Fibre** - the list-box provides three options to draw the fibre labels:
 - **Outside** of the cross-section;
 - **Inside** of the outline of cross-section;
 - **No label**.
- **Bars numbers** - shows/hides the bar numbers.
- **Tendon numbers** – shows/hides the tendon numbers.
- **Extreme fibre** - highlights the extremely loaded fibre(s).
- **Extreme bar** - highlights the extremely loaded reinforcement bar(s).
- **Extreme tendon** - highlights the extremely loaded tendon(s).
- **+** - increase concrete fibre labels.
- **-** - decrease concrete fibre labels.

Options for tendons are available only for staged sections.

13.10.14.2 Ribbon group Extreme labels



- **Fibre** - shows/hides the stress and strain values at the most loaded fibre(s).
- **Bar** - shows/hides the stress and strain values at the most loaded reinforcement bar.
- **Tendon** - shows/hides the stress and strain values at the most loaded tendon.

Options for tendons are available only for staged sections.

13.10.14.3 Ribbon group Stress-strain relationship

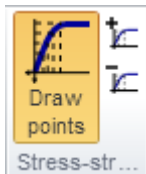

- **Draw points** - shows/hides the values of points on parabolic part of stress-strain interaction.
- **+** - increase the number of points on parabolic part of stress-strain relationship.
- **-** - decrease the number of points on parabolic part of stress-strain relationship.

13.11 Fatigue check

To display results of the fatigue check for the current section and the current loads extreme click navigator command **Results** and tab **Fatigue** in the Data window.

Ribbon groups **View**, **View setting**, **Checked directions**, **Strain**, **Stress**, **Results label**, **Result graph**, **Results**, **Cross-section**, **Type of results**, **Fatigue combination** and **Calculation** are available.

In the Main graphical window the check is displayed, in the Data window the detailed text representation of the check is printed.

13.11.1 Ribbon group View

See [Ribbon group View](#).

13.11.2 Ribbon group View setting

See [Ribbon group View setting](#).

13.11.3 Ribbon group Checked directions

See [Setting of the checked direction for 2D members section checks](#).

13.11.4 Ribbon group Strain

See [Ribbon group Strain](#).

13.11.5 Ribbon group Stress

See [Ribbon group Stress](#).

13.11.6 Ribbon group Results label

See [Ribbon group Results label](#).

13.11.7 Ribbon group Results graph

See [Ribbon group Results graph](#).

13.11.8 Ribbon group Resultant forces

See [Ribbon group Resultant forces](#).

13.11.9 Ribbon group Cross-section

See [Ribbon group Cross-section](#).

13.11.10 Ribbon group Type of results

See [Ribbon group Type of results](#).

13.11.11 Ribbon group Fatigue combination



Use this ribbon group to set the combination for drawing of stress and strain courses of the cross-section.

- **Min. cyclic loads** – switch to draw results for the fatigue combination, which contains variable loads for calculation of minimal stress range.
- **Max. cyclic loads** – switch to draw results for the fatigue combination, which contains variable loads for calculation of maximal stress range.

13.11.12 Ribbon group Calculation

See Calculation mode settings.

13.12 Stress limitation check

To display results of the stress limitation check for the current section and the current loads extreme click navigator command **Results** and tab **Stress limitation** in the Data window.

Ribbon groups **View**, **View setting**, **Checked directions**, **Strain**, **Stress**, **Results label**, **Result graph**, **Results**, **Cross-section**, **Type of results**, **Export**, **Calculation** and **Code and calculation settings** are available.

13.12.1 Ribbon group View

See [Ribbon group View](#).

13.12.2 Ribbon group View setting

See [Ribbon group View setting](#).

13.12.3 Ribbon group Checked directions

See [Setting of the checked direction for 2D members section checks](#).

13.12.4 Ribbon group Strain

See [Ribbon group Strain](#).

13.12.5 Ribbon group Stress

See [Ribbon group Stress](#).

13.12.6 Ribbon group Results label

See [Ribbon group Results label](#).

13.12.7 Ribbon group Results graph

See [Ribbon group Results graph](#).

13.12.8 Ribbon group Results

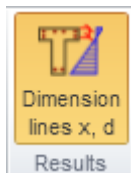

- **Dimension lines x, d** – shows/hides the dimension lines for the position of neutral axis.

13.12.9 Ribbon group Cross-section

See [Ribbon group Cross-section](#).

13.12.10 Ribbon group Type of results

See [Ribbon group Type of results](#).

13.12.11 Ribbon group Export

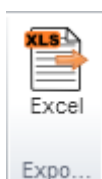

- **Excel** – start export of cross-section fibres and detailed check results of stress limitation check in particular fibres to the Microsoft Excel table.

13.12.12 Ribbon group Calculation

See **Calculation mode settings**.

13.12.13 Ribbon group Code and calculation settings

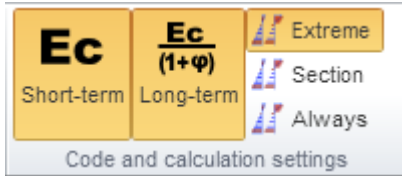

Some options of **Code and calculation settings** dialog are directly available in this ribbon group:

- **Long-term** – switch on/off taking into account long-term effect in cross-section check.
- **Short-term** – switch on/off taking into account short-term effect in cross-section check.
- **Extreme** – switch on taking into account no resistance of concrete in tension in all SLS checks for the current load extreme only.
- **Section** – switch on taking into account no resistance of concrete in tension in all SLS checks for all load extremes in the current section.
- **Always** - switch on taking into account no resistance of concrete in tension in all SLS checks for all load extremes in all sections.

13.13 Crack width check

To display results of the crack width check for the current section and the current loads extreme click navigator command **Results** and tab **Crack width** in the Data window.

Ribbon groups **View**, **Checked directions**, **View setting**, **Strain**, **Stress**, **Results label**, **Results graph**, **Results**, **Cross-section**, **Type of results**, **Export**, **Calculation** and **Code and calculation settings** are available.

In the Main graphical window the check is drawn, in the Data window the detailed text representation of the check is printed.

13.13.1 Ribbon group View

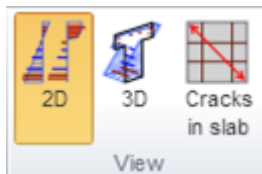

- **2D** – turns on drawing of results in 2D picture (cross-section areas, courses of stress and strain)
- **3D** – turns on drawing of courses of stress and strain of concrete and reinforcement in 3D view
- **Crack in slabs** – turns on drawing of crack in slabs. This button is available only for 2D sections. Ribbon group Cracks is available when drawing the crack to change the drawing scale of crack.

13.13.2 Ribbon group Checked directions

See [Setting of the checked direction for 2D members section checks](#).

13.13.3 Ribbon group View setting

See [Ribbon group View setting](#).

13.13.4 Ribbon group Strain

See [Ribbon group Strain](#).

13.13.5 Ribbon group Stress

See [Ribbon group Stress](#).

13.13.6 Ribbon group Results label

See [Ribbon group Results label](#).

13.13.7 Ribbon group Results graph

See [Ribbon group Results graph](#).

13.13.8 Ribbon group Results

See [Ribbon group Results](#).

13.13.9 Ribbon group Cross-section

See [Ribbon group Cross-section](#), except buttons for highlighting of extreme fibres, which has no sense for crack width check.

13.13.10 Ribbon group Type of results

See [Ribbon group Type of results](#).

13.13.11 Ribbon group Export

See [Ribbon group Export](#).

13.13.12 Ribbon group Calculation

See [Calculation mode settings](#).

13.13.13 Ribbon group Code and calculation settings

See [Ribbon group Code and calculation settings](#).

13.13.14 Ribbon group Cracks



This group is available when drawing of crack on slabs is active after clicking **Crack** in slabs in ribbon group **View**.

The crack size can be adjusted by clicking the button for scale increase/decrease.

13.14 Flexural slenderness check

To display results of the flexural slenderness check according to article EN 1992: 7.4.2 for the current section and the current loads extreme click navigator command **Results** and tab **Flexural slenderness** in the Data window.

In the Main graphical window the static scheme of beam with supports and effective length is drawn.

In the Data window a detailed text representation of the flexural slenderness check is printed.

Ribbon group **Calculation** is available - see [Calculation mode settings](#).

13.15 Brittle failure check

To display results of the brittle failure check for the current section and the current loads extreme click navigator command **Results** and tab **Brittle failure** in the Data window.

This check is available only for prestressed reinforced sections for code EN 1992-2.

Graphical scheme of reinforced cross-section is drawn in Main window.

In the Data window detailed the text representation of the brittle failure check is printed.

Ribbon group **Calculation** is available - see [Calculation mode settings](#).

13.16 Detailing check

To display results of the detailing rules check for the current section and the current loads extreme click navigator command **Results** and tab **Detailing** in the Data window.

The content in the Main graphical window is the same as described in chapter **Overall check**.

In the Data window detailed the text representation of the detailing rules check is printed.

Ribbon groups **Components label** and **Calculation** are available.

13.16.1 Ribbon group Components label

See **Ribbon group Component labels**.

13.16.2 Ribbon group Calculation

See **Calculation mode settings**.

13.17 Response check

To display results of the cross-section response check for the current section and current loads extreme click navigator command **Results** and tab **Response N-M-M** in the Data window.

In the Main graphical window the check is drawn, in the Data window the detailed text representation of the check is printed.

Ribbon groups **Combinations**, **View**, **View setting**, **Checked directions**, **Strain**, **Stress**, **Results label**, **Results graph**, **Resultant forces**, **Cross-section**, **Type of results** and **Calculation** are available.

13.17.1 Ribbon group Combinations

See [Setting the evaluated combination.](#)

13.17.2 Ribbon group View

See [Ribbon group View.](#)

13.17.3 Ribbon group View setting

See [Ribbon group View setting.](#)

13.17.4 Ribbon group Checked directions

See [Setting of the checked direction for 2D members section checks.](#)

13.17.5 Ribbon group Strain

See [Ribbon group Strain.](#)

13.17.6 Ribbon group Stress

See [Ribbon group Stress.](#)

13.17.7 Ribbon group Results label

See [Ribbon group Results label.](#)

13.17.8 Ribbon group Results graph

See [Ribbon group Results graph.](#)

13.17.9 Ribbon group Resultant forces

See [Ribbon group Resultant forces.](#)

13.17.10 Ribbon group Cross-section

See [Ribbon group Cross-section.](#)

13.17.11 Ribbon group Type of results

See [Ribbon group Type of results.](#)

13.17.12 Ribbon group Calculation

See [Calculation mode settings.](#)

13.18 Stiffness calculation

To display results of the short and long term stiffness calculation of the cross-section for the current section and loads extreme click navigator command **Results** and tab **Stiffnesses** in the Data window.

Ribbon groups **View**, **View setting**, **Strain**, **Stress**, **Results label**, **Results graph**, **Results**, **Cross-section**, **Stiffness**, **Type of results**, **Calculation** and **Code and calculation settings** are available.

In the Main graphical window the check is drawn, in the Data window the detailed text representation of the calculation is printed.

13.18.1 Ribbon group View

See [Ribbon group View](#). Buttons **3D forces** and **Diagrams** are not available.

13.18.2 Ribbon group View setting

See [Ribbon group View setting](#).

13.18.3 Ribbon group Strain

See [Ribbon group Strain](#).

13.18.4 Ribbon group Stress

See [Ribbon group Stress](#).

13.18.5 Ribbon group Results label

See [Ribbon group Results label](#).

13.18.6 Ribbon group Results graph

See [Ribbon group Results graph](#).

13.18.7 Ribbon group Results

See [Ribbon group Results](#).

13.18.8 Ribbon group Cross-section

See [Ribbon group Cross-section](#), except buttons for highlighting of extreme fibres, which has no sense for stiffness calculation.

13.18.9 Ribbon group Type of results

See [Ribbon group Type of results](#).

13.18.10 Ribbon group Calculation

See [Calculation mode settings](#).

13.18.11 Ribbon group Code and calculation settings

See [Ribbon group Code and calculation settings](#).

13.19 Calculation of M-N- κ diagram

To display results of the calculation of M-N- κ diagram for the current section and the current loads extreme click navigator command **Results** and tab **M-N- κ** in the Data window.

Ribbon groups **View**, **M-N- κ** , **View setting**, **Strain**, **Stress**, **Results label**, **Results graph**, **Results** and **Cross-section** are available.

In the Main graphical window the check is drawn, in the Data window the detailed text representation of the calculation is printed.

13.19.1 Ribbon group View

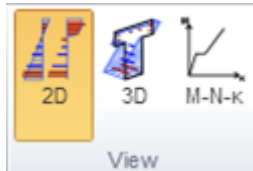

- **2D** – turns on drawing of results in 2D picture (cross-section areas, courses of stress and strain)
- **3D** – turns on drawing of courses of stress and strain of concrete and reinforcement in 3D view
- **M-N- κ** – turns on drawing of M-N- κ diagram

13.19.2 Ribbon group M-N- κ

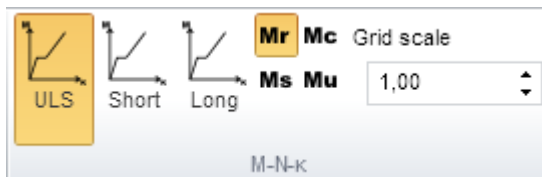

Use commands in ribbon group **M-N- κ** to set the drawing of M-N- κ diagram.

- **ULS** – switch to drawing of diagram on ULS or drawing of stress-strain courses on ULS and the selected moment of the diagram.
- **Short** - switch to drawing of diagram for short term effect of load actions or drawing of stress-strain courses for short-term effects and the selected moment of the diagram.
- **Long** - switch to drawing of diagram for long term effect of load actions or drawing of stress-strain courses for long-term effects and the selected moment of the diagram.
- **Mr** – switch to drawing of stress-strain courses for the current diagram type and moment on concrete cracking
- **Mc** – switch to drawing of stress-strain courses for the current diagram type and moment on concrete plasticity
- **Ms** – switch to drawing of stress-strain courses for the current diagram type and moment on reaching yield strength of reinforcement steel.
- **Mu** – switch to drawing of stress-strain courses for the current diagram type and moment on ultimate limit state

13.19.3 Ribbon group View setting

See [Ribbon group View setting](#).

13.19.4 Ribbon group Strain

See [Ribbon group Strain](#).

13.19.5 Ribbon group Stress

See **Ribbon group Stress**.

13.19.6 Ribbon group Results label

See **Ribbon group Results label**.

13.19.7 Ribbon group Results graph

See **Ribbon group Results graph**.

13.19.8 Ribbon group Results

See **Ribbon group Results**.

13.19.9 Ribbon group Cross-section

See **Ribbon group Cross-section**.

14 Materials database

Materials in project can be modified or stored to the user database using navigator command **Project summary > Materials**.

Concrete
Reinforcement
Prestressed steel

	Name		
1	C30/37		
2	C35/45		
3	C16/20		

Name	C30/37	
Physical properties		
m	2500	kg/m ³
EN 1992-1-1		
f _{ck}	30,0	MPa
Calculate dependent values	<input checked="" type="checkbox"/>	
E _{cm}	32836,6	MPa
f _{cm}	38,0	MPa
f _{ctm}	2,9	MPa
f _{ctk,0,05}	2,0	MPa
f _{ctk,0,95}	3,8	MPa
ε _{c2}	20,0	1e-4
ε _{cu2}	35,0	1e-4
Exponent - n	2,00	-
ε _{c3}	17,5	1e-4
ε _{cu3}	35,0	1e-4
Aggregate size	2	cm
Aggregate type	Quartzite	▼
Cement class	R	▼
Diagram type	Parabolic	▼
Diagram for plain concrete	<input type="checkbox"/>	

Following data is displayed in the main window:

- List of concrete materials in project on the tab **Concrete**.
- List of concrete reinforcement materials on the tab **Reinforcement**.
- List of prestressing reinforcement materials on the tab **Prestressing reinforcement**.

Appropriate table of material properties is displayed for selected material. Change of material property affects all project items, which have assigned the modified material.

Columns in material tables:

- **Name** – name of material is displayed.
- - click the button to display the dialog with the list of all materials available in the system material library. When a material from the library is selected, it replaces the edited material. The change affects all project items, which have assigned the modified material.
- - save the current material to selected or new table of materials in user database.

15 Code and calculation settings

Click button **Code** in ribbon group **Setting** to set the national code values and calculation variables.

Code dependent variables are grouped according to chapters and articles (clauses) of the code. Last group **General** contains settings of general (not code dependent) calculation values.

If national annex is enabled (using command **Code** in **Project data** dialog), values of national annex can be changed or default value of EC code can be used.

To display tool-tip with detailed information about code variable point mouse cursor on row with code variable.

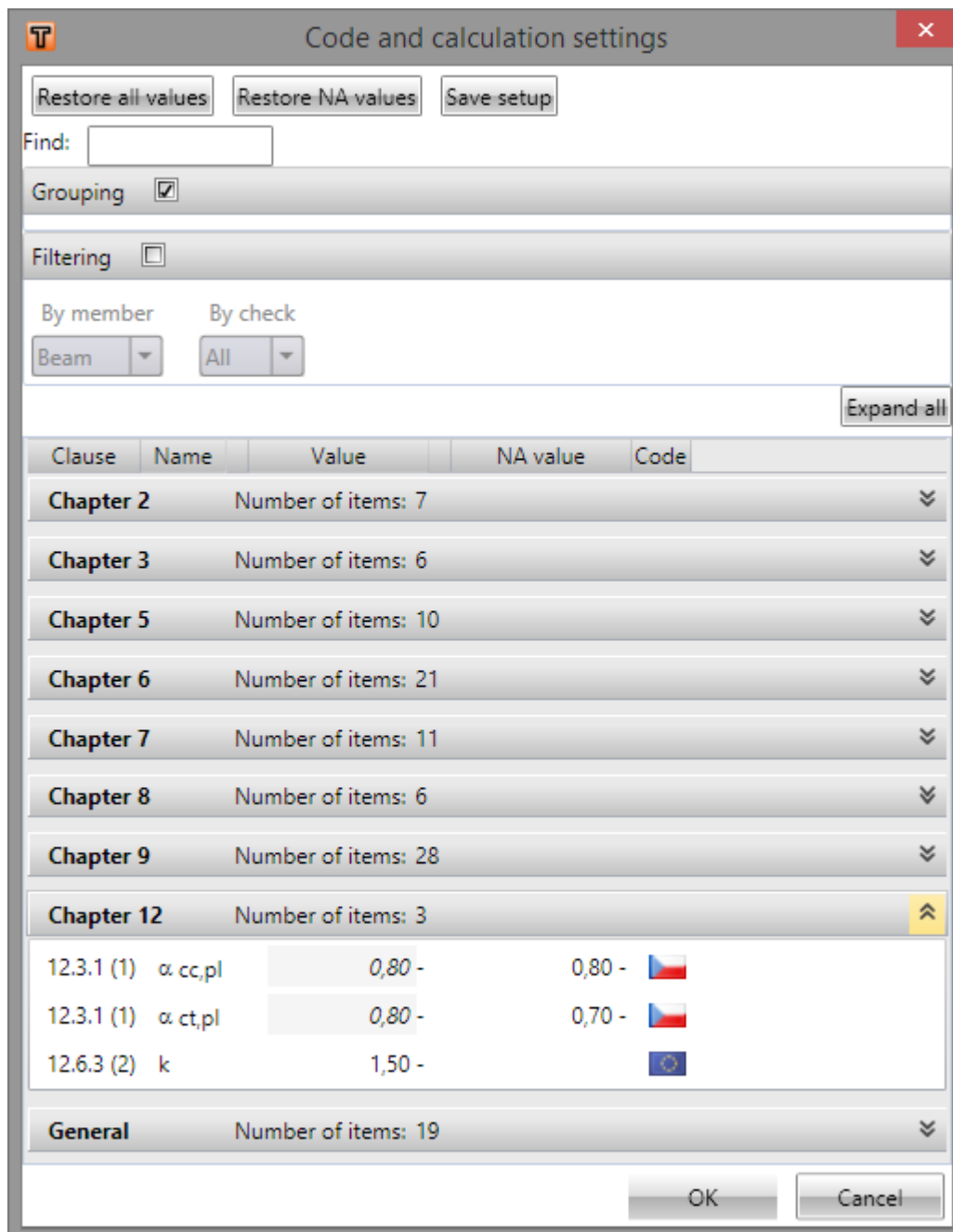

- **Restore all values** – resets all values of code settings for EC and current national annex to default code and annex values.
- **Restore NA values** – resets values of current national annex to default annex values.

- **Save setup** – saves current code settings to file. Saved settings can be loaded into other project clicking **Code** button in **Project data** dialog. To display **Project data** dialog click **Project data** in ribbon group **Settings**.
- **Find** – after entering a value in the text box, this function filters out those available code variables that contain the entered value of the article number.
- **Grouping** – turns on/off the grouping of code variables by chapter. When grouping is on, you can collapse or expand individual chapters of code variables.
- **Filtering** – turns on/off the filtering of code variables by chapter. When filtering is on, you can choose filtering criteria **By member** or **By check**.

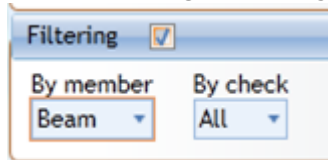

- **Expand all/Collapse all** – when grouping is on, you can expand or collapse all the code variable chapters.
- **Column Clause** – numbers of particular code clauses are displayed in this column.
- **Column Name** – names of code variables are displayed in this column.
- **Column Value** – code variable values can be edited in this column. If there is a checkbox at code value, it can turn the value on/off to be taken into account or neglected in the check. Values of code variables can be edited only if column **Code** is set to EC-EN.
- **Column Value NA** – value of national annex can be edited in this column if national annex value is available for particular code setting item. Values of annex variables can be edited only if column **Code** is set to national annex.
- **Column Code** – flag in column indicates, which code is active for particular code setting item. Click flag icon to switch between national annex and EC code.

16 Application setting

16.1 Units setting

The units used by the application can be set by clicking button **Units** in ribbon group **Settings** of the page **Home**.

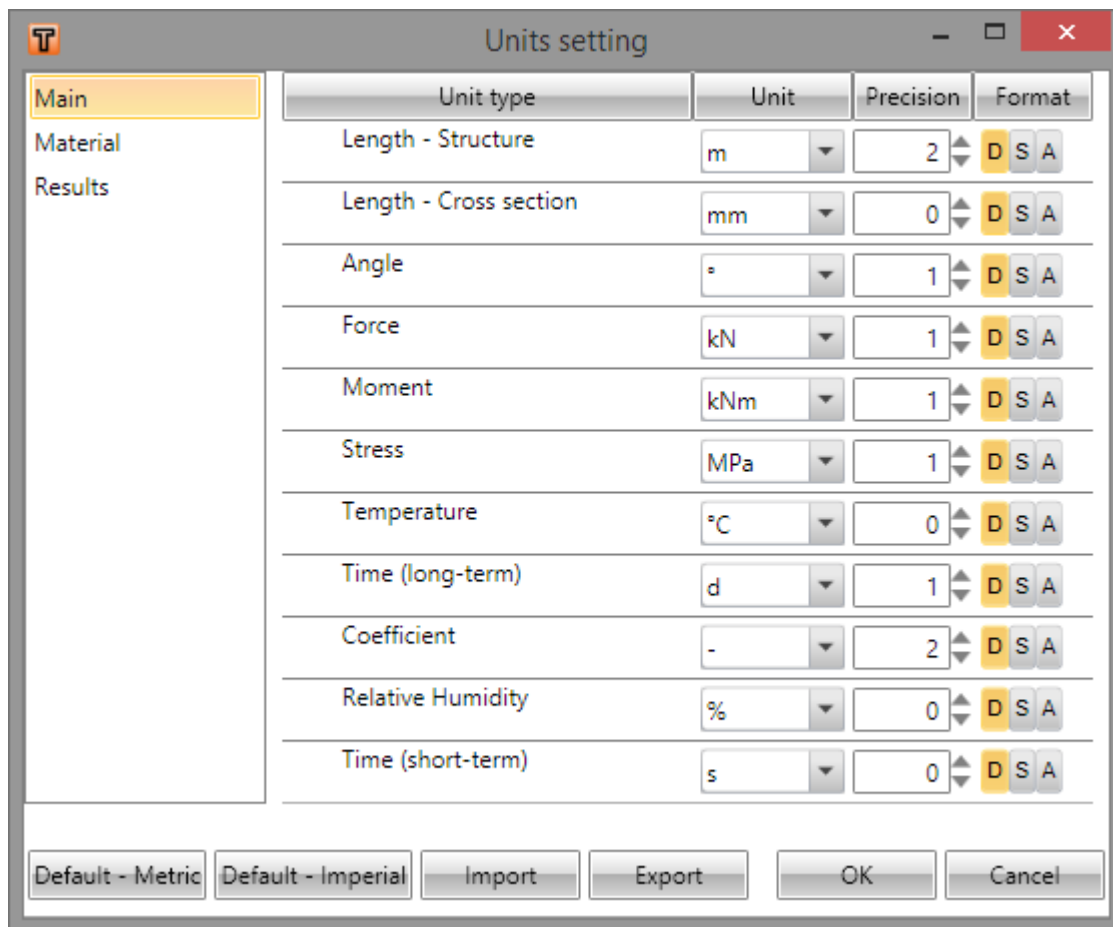

Magnitudes, for which the units can be set, are grouped into categories Main, Material and Results. The categories are displayed in the column on the left of the dialog. For the selected category the table of corresponding magnitudes is displayed. For each magnitude, which is listed in column **Unit type**, one of the available units can be set in the column **Unit**.

For each magnitude the number of digits to be displayed after decimal point can be set in the column **Precision**.

Style of numbers presentation can be set in **Format** column:

- **D** – display numbers in standard decimal format (“ ddd.ddd...”).
- **S** – display numbers in exponential format (“ d.ddd...E+ddd”).
- **A** – according to length of resulting string it is automatically chosen whether to use decimal or exponential format. In this mode value specified in **Precision** column means number of significant digits in the resulting string.
- **Default – metric** – loads default units settings for metric units system.
- **Default – imperial** – loads default units settings for imperial units system.
- **Import** - reads the units configuration from a file.
- **Export** - saves the current units settings to a file.

Click **OK** to apply the changes and to be used at next application start.

16.2 Application global settings

To change colours, line thicknesses, text heights settings click button **Application** in ribbon group **Setting** on panel **Home**.

16.2.1 Results drawing settings

Drawing colours for individual result types can be set on tab **Results** of **Application settings** dialog.

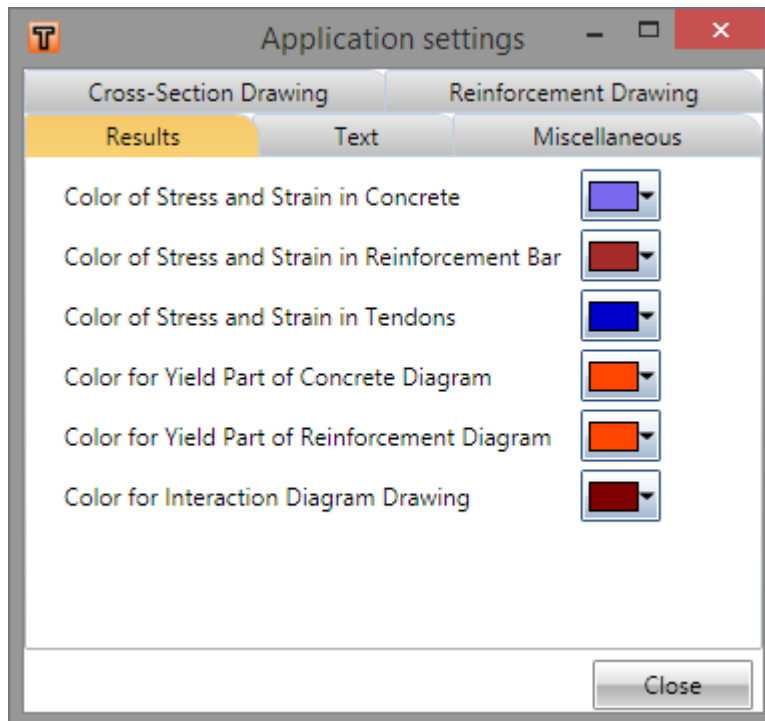

16.2.2 Reinforcement drawing settings

Drawing colours for individual types of reinforcement can be set on tab **Reinforcement drawing** of **Application settings** dialog.

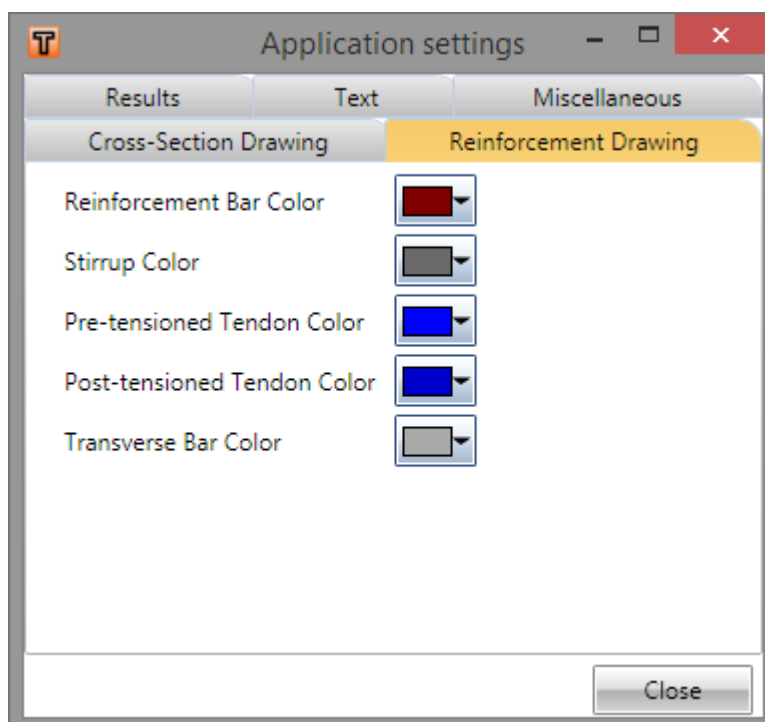

16.2.3 Cross-section drawing setting

Outline thickness (negative value is relative thickness) and cross-section drawing colour can be set on tab **Cross-Section drawing** of **Application settings** dialog.

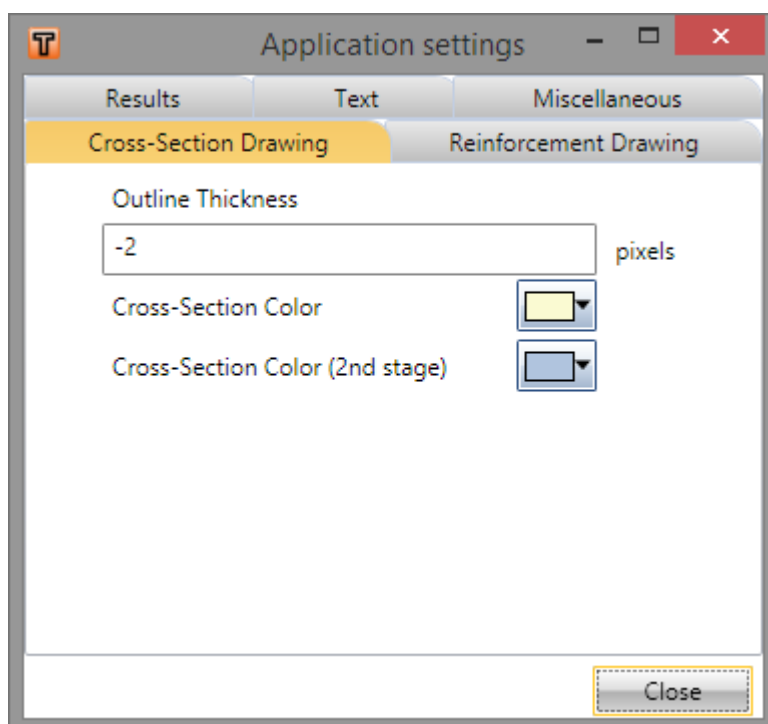

16.2.4 Text height settings

Text height used for the reinforced cross-section drawings and the result drawings can be set on tab **Text** of **Application settings** dialog.

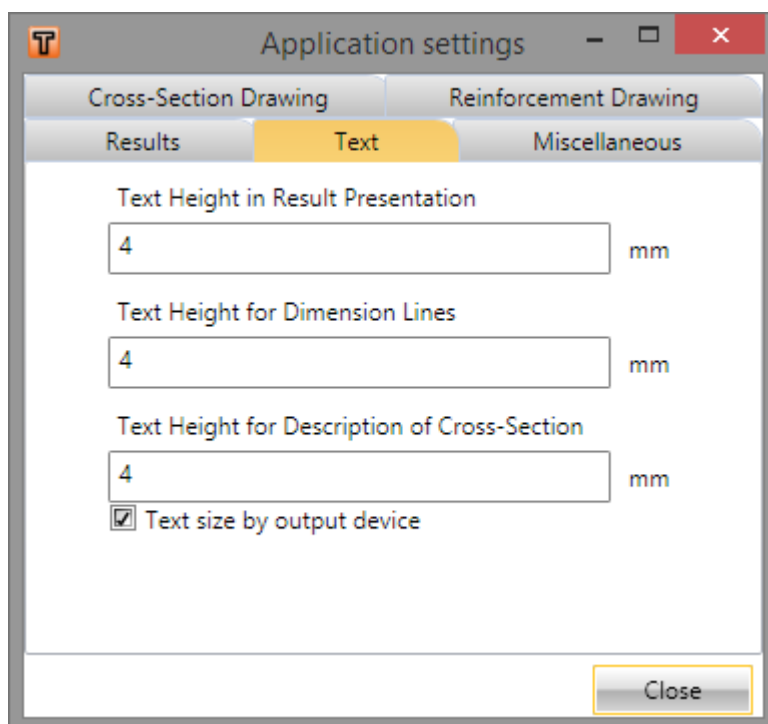

16.2.5 Miscellaneous settings

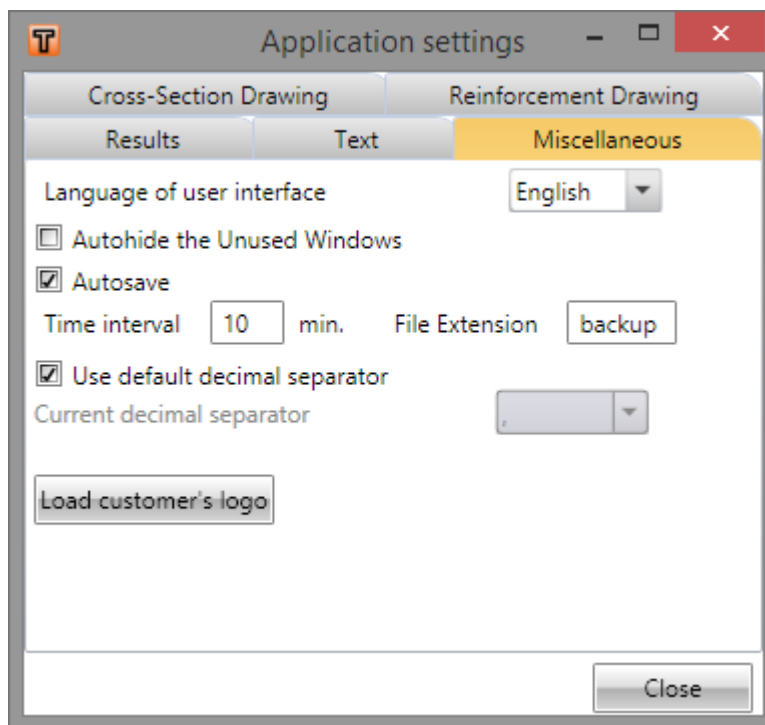

- **Language of user interface** – select required language in the list. Changes are applied after restart of application
- **Autohide the unused windows** – turns on/off automatic hiding the unused windows with empty content (Info window, Data window). The change is taken into account after restarting the application.
- **Autosave** – turns on/off automatic saving of actual data in the defined time interval. Automatic saving is only possible when a file extension is set in the textbox.
- **Use default decimal separator** – if the checkbox is off, decimal separator can be set in list **Current decimal separator**. Otherwise decimal separator specified in **Regional settings** is used.
- **Load customer's logo** – after clicking this button it is possible to select an image file (jpg, gif) to be used on the top right corner of the report.

17 Format of text files for import and export

17.1 File TXT

To export and import cross-section and reinforcement data, text files are used. A txt file can be used to import the outline of cross-section, openings, longitudinal reinforcement, stirrups, prestressing tendons and tendon ducts.

To import a cross-section shape, one vertex of outline is defined on each line in the text file. Coordinates y and z are separated by a space. An example of the file for import of a rectangle cross-section is:

```
-150 -250
150 -250
150 250
-150 250
-150 -250
```

To import an opening, one vertex of opening is defined at each line in the text file. Coordinates y and z are separated by a space. An example of the file for import of a rectangle hole:

```
-50 -50
50 -50
50 50
-50 50
-50 -50
```

To import a longitudinal reinforcement layout, one layer is defined at each line in the text file. It is mandatory that the parameters must be defined in the following order: *numbers of bars, bar diameter, begin Y coordinate, end Y coordinate, begin Z coordinate, end Z coordinate*. An example of a file for the import of two bar layers is:

```
2 16 352 252 -352 252
2 16 -352 -252 352 -252
```

To import a stirrups layout there is one stirrup layout definition at each line in the text file. It is mandatory that the parameters must be defined in following order: *stirrup diameter, the distance between two adjacent stirrups, take into account the torsion check (0=no, 1=yes), the radius of mandrel (multiple of stirrup diameter)*. The example of the file for the import of one stirrup is as follows:

```
10 300 1 1.30
-365 265
-365 -265
365 -265
365 265
-365 265
```

To import a tendons layer defined by coordinates of first and last tendon in layer, one layer is defined at each line in the text file. It is mandatory that the parameters must be defined in the following order: *number of tendons in layer, number of strands in tendon, order of prestressing, vertical slope of tendon, horizontal slope of tendon, begin Y, begin Z, end Y, end Z, pre/post-tensioned (1=post-tensioned, 0=pre-tensioned), duct diameter, duct material (0=metal, 1=plastic)*

An example of a file for the import of one layer of tendons defined by coordinates:

```
2 6 1 0.0 0.0 -120 -190 120 -190 1 33 0
```

To import a tendons layer defined at cross-section edge, one layer is defined at each line in the text file. It is mandatory that the parameters must be defined in the following order: *number of tendons in layer, number of strands in tendon, 1, vertical slope of tendon, horizontal slope of tendon, order of prestressing, number of edge, edge cover, left cover, right cover, pre/post-tensioned (1=post-tensioned, 0=pre-tensioned), duct diameter, duct material (0=metal, 1=plastic)*

An example of a file for the import of one layer of tendons at cross-section edge

```
2 6 1 0.0 0.0 1 1 30 30 30 1 33 0
```

To import a ducts layer defined by coordinates of first and last duct in layer, one layer is defined at each line in the text file. It is mandatory that the parameters must be defined in the following order: *number of ducts in layer, duct diameter, begin Y, begin Z, end Y, end Z, duct material (0=metal, 1=plastic)*

An example of a file for the import of one layer of ducts defined by coordinates:

```
2 33 -120 -220 120 -220 0
```

To import a ducts layer defined at cross-section edge, one layer is defined at each line in the text file. It is mandatory that the parameters must be defined in the following order: *number of ducts in layer, ducts diameter, number of edge, edge cover, left cover, right cover, duct material (0=metal, 1=plastic)*

An example of a file for the import of one layer of ducts at cross-section edge

```
2 33 1 4 30 30 30 0
```

17.2 File .NAV

NAV file includes XML tags for the defined groups of data. File in NAV format enables to import the whole reinforced cross-section (outline, openings, longitudinal reinforcement, stirrups, tendons and tendon ducts) at once. The following tags are used:

- **<ReinforcedCss> </ReinforcedCss>** - begin and end tag for reinforced section. It can include tags <Css>, <Bars>, <Stirrups>, <Tendons> and <TendonDucts>
- **<Css> </Css>** - begin and end tag for the definition of a cross-section shape. It contains tags <Component> and <Opening>
 - **<Component> </Component>** - begin and end tag for the definition of one cross-section component. The content includes lines with vertex coordinates for the cross-section shape.
 - **<Opening> </Opening>** - begin and end tag for one opening in cross-section. The content includes lines with vertex coordinates for the opening shape.

- **<Bars> </Bars>** - begin and end tag for the definition of the longitudinal reinforcement. The content includes lines with the same reinforcement bars description as defined in the TXT file.
- **<Stirrups> </Stirrups>** - begin and end tag for the definition of one stirrup. It contains the tags **<DataStirrup>** and **<GeometryStirrup>**
 - **<DataStirrup> </DataStirrup>** - it contains the lines with the same general stirrup parameters as defined in the TXT file.
 - **<GeometryStirrup></GeometryStirrup>** - it contains the lines with the same vertex coordinates as defined in the TXT file
- **<Tendons> </Tendons>** - begin and end tag for definition of prestressing tendons. It contains tags **<TendonsInLine>** and **</TendonsOnCssEdge>**.
 - **<TendonsInLine></TendonsInLine>** - contains lines with the same tendons defined by coordinates description as defined in the TXT file.
 - **<TendonsOnCssEdge></TendonsOnCssEdge >** - contains lines with the same tendons at cross-section edge description as defined in the TXT file.
- **<TendonDucts> </TendonDucts>** - begin and end tag for definition of tendon ducts. Contains tags **<TendonDuctsInLine>** and **</TendonDuctsOnCssEdge>**.
 - **<TendonDuctsInLine ></TendonDuctsInLine >** - contains lines with the same ducts defined by coordinates description as defined in the TXT file.
 - **<TendonDuctsOnCssEdge ></TendonDuctsOnCssEdge >** - contains lines with the same ducts at cross-section edge description as defined in the TXT file.

An example of a complete reinforced cross-section exported to .NAV file is as follows:

```
<ReinforcedCss>
  <Css>
    <Component>
      -150 -250
      150 -250
      150 250
      -150 250
      -150 -250
    </Component>
    <Opening>
      -50 -50
      50 -50
      50 50
      -50 50
      -50 -50
    </Opening>
  </Css>
  <Bars>
    2 16 102 202 -102 202
    2 16 -102 -202 102 -202
  </Bars>
  <Stirrups>
    <Stirrup>
      <DataStirrup>
        10 200 1 1.30
      </DataStirrup>
      <GeometryStirrup>
        -115 215
        -115 -215
        115 -215
        115 215
        -115 215
      </GeometryStirrup>
```

```
</Stirrup>
</Stirrups>
<Tendons>
  <TendonsInLine>
    2 6 1 0.0 0.0 -110 210 110 210 1 33
  </TendonsInLine>
  <TendonsOnCssEdge>
    2 6 1 0.0 0.0 1 1 30 30 30 1 33
  </TendonsOnCssEdge>
</Tendons>
  <TendonDucts>
    <TendonDuctsOnCssEdge>
      2 1.7 1 2 80 30 30
    </TendonDuctsOnCssEdge>
  </TendonDucts>
</ReinforcedCss>
```

17.3 Import from XML file

If IDEA RCS is started from superior application, import from XML is not available.

Sections of 1D and 2D members for reinforcement design can be imported from XML file. Loads extremes can be imported too. XML file is expected to be exported from program SCIA Engineer.

Import from versions 2010.0 and higher is supported, import from version 2009 is limited.

XML document for export into IDEA RCS must contain following tables:

- Cross-sections
- Materials
- Members 1D
- Haunches (SCIA Engineer 2010 and higher)
- Arbitrary members (SCIA Engineer 2010 and higher)
- 2D members (SCIA Engineer 2010 and higher)
- Load cases
- Combinations
- Named selection (SCIA Engineer 2010 and higher)

If sections for check of 1D member or 2D members should be generated, XML document should contain following chapters, respectively:

- Internal forces on members
- Member 2D – internal forces

To generate XML file with correct content tables of appropriate XML document chapters has to be generated (adapted). Tables must fulfill rules described in following paragraphs.

Content of XML document (list of chapters) can be loaded from template files, which are included in installation package of IDEA RCS:

- \Templates\IDEA_importRCS1D.TDX (for SCIA Engineer 2010 and higher)
- \Templates\IDEA_importRCS1D_2009.TDX (for SCIA Engineer 2009)

Edited templates are stored in files

- \Templates\otx_2010.zip (for SCIA Engineer 2010 and higher)
- \Templates\otx_2009.zip (for SCIA Engineer 2009)

Template files from the appropriate package otx_20xx.zip have to be unpacked into the following directory:

- xxx\DocumentTemplates\xml\, where xxx is User Settings Directory of SCIA Engineer application. Default full path of this directory is eq. for SCIA Engineer 2009: c:\Users_user_name_\ESA90\user\DocumentTemplates\XML\

17.3.1 Cross-sections

Import of following cross-section types is supported:

a) all cross-section from **Concrete** group are converted to standard concrete sections in IDEA RCS (can be reinforced using reinforcement templates in IDEA RCS)

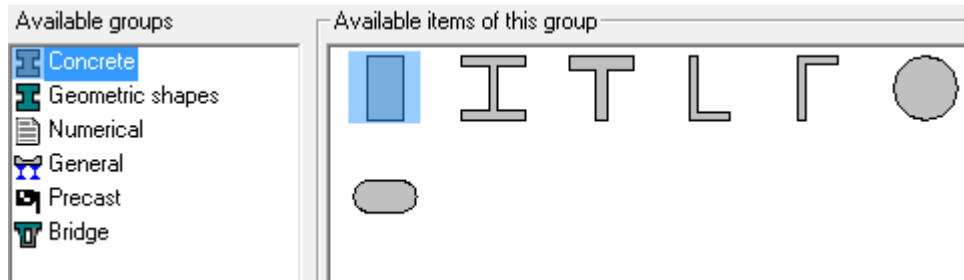

b) all cross-sections from **Geometric shapes** group can be imported into IDEA RCS. Cross-sections in green frames are converted to general cross-section (cannot be reinforced using reinforcement templates), other cross-sections are converted to standard concrete cross-sections (can be reinforced using reinforcement templates)

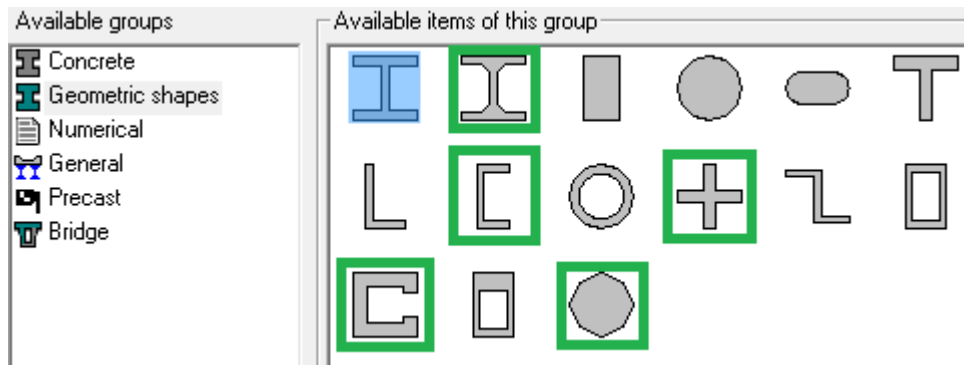

c) all cross-sections from **Precast** group can be imported into IDEA RCS. Cross-sections are imported as general cross-sections (defined by vertices).

Cross-sections in red frames are converted to one component cross-sections, because current IDEA RCS does not support more components in cross-section. If components of imported cross-section have different materials, material from first component is used for imported cross-section.

Cross-section Double T shape (in green frame) is imported as standard Double T, provided that haunch on webs is zero.

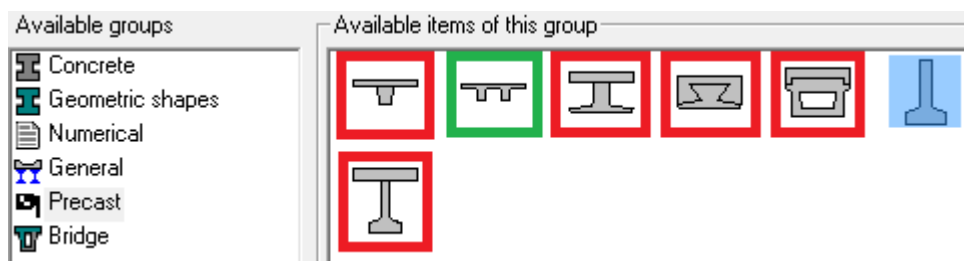

Shapes of particular precast bridge cross-sections after import into IDEA RCS:

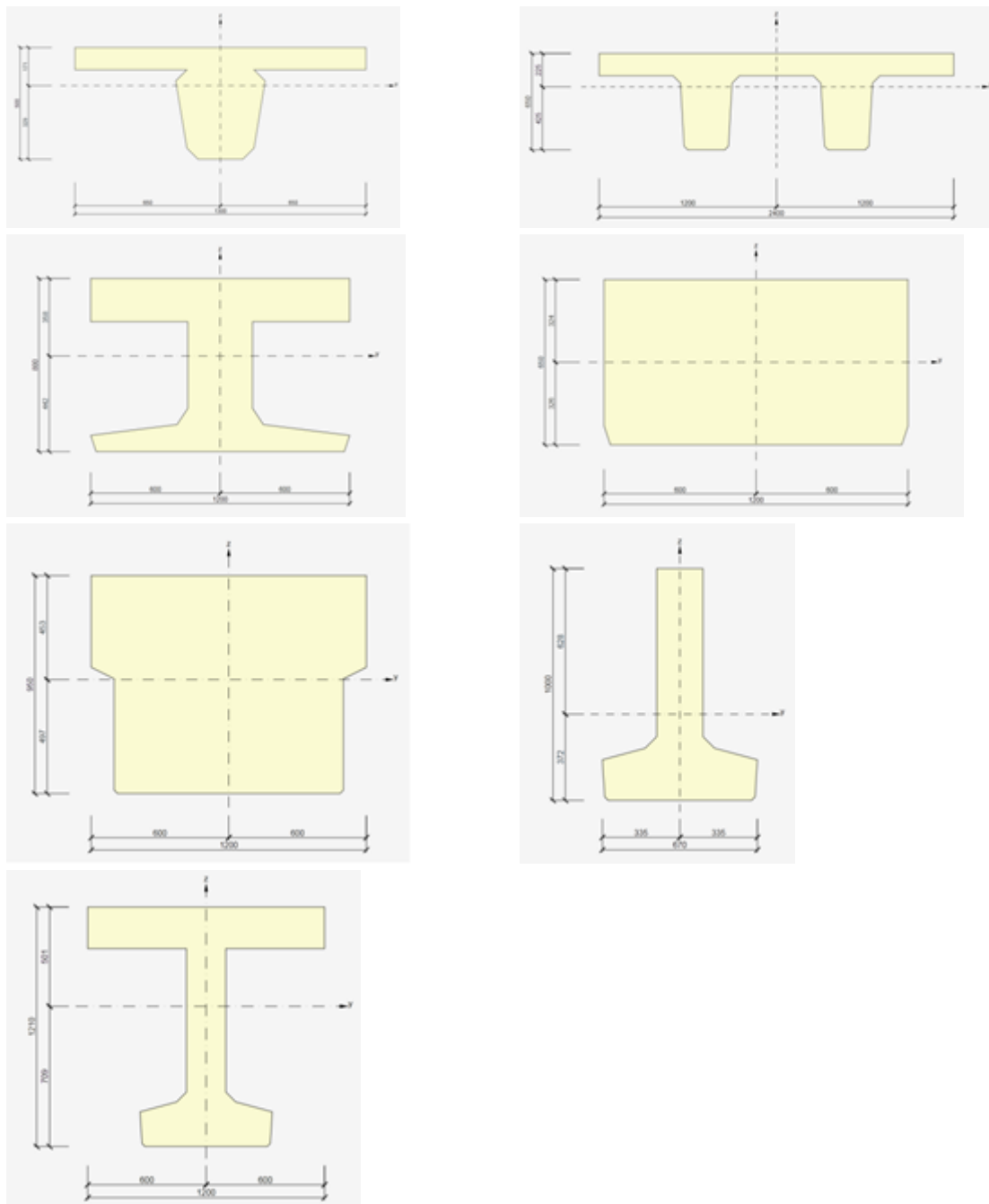

d) all cross-sections from **Bridge** group can be imported into IDEA RCS. Cross-sections are imported as general cross-sections (defined by vertices).

Cross-sections in red frames are converted to one component cross-sections, because current IDEA RCS does not support more components in cross-section. If components of imported cross-section have different materials, material from first component is used for imported cross-section.

Cross-sections in dark green frames are imported as standard Double T, provided that haunches on cross-sections are zero.

Cross-section T in blue frame is imported as standard T with haunches on flange, provided that haunches on flange of imported cross-section are non-zero.

Cross-sections in light green frames are imported as standard I shape, provided that haunches are zero.

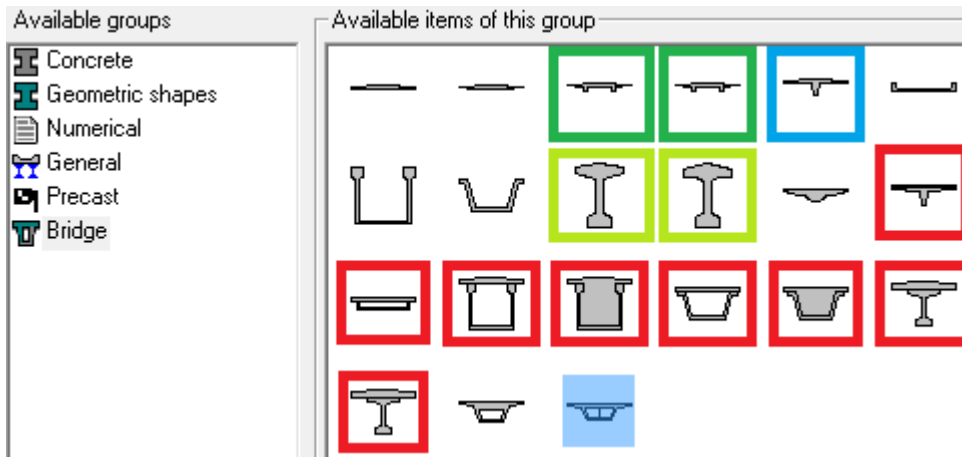

Shapes of bridge cross-sections after import into IDEA RCS:

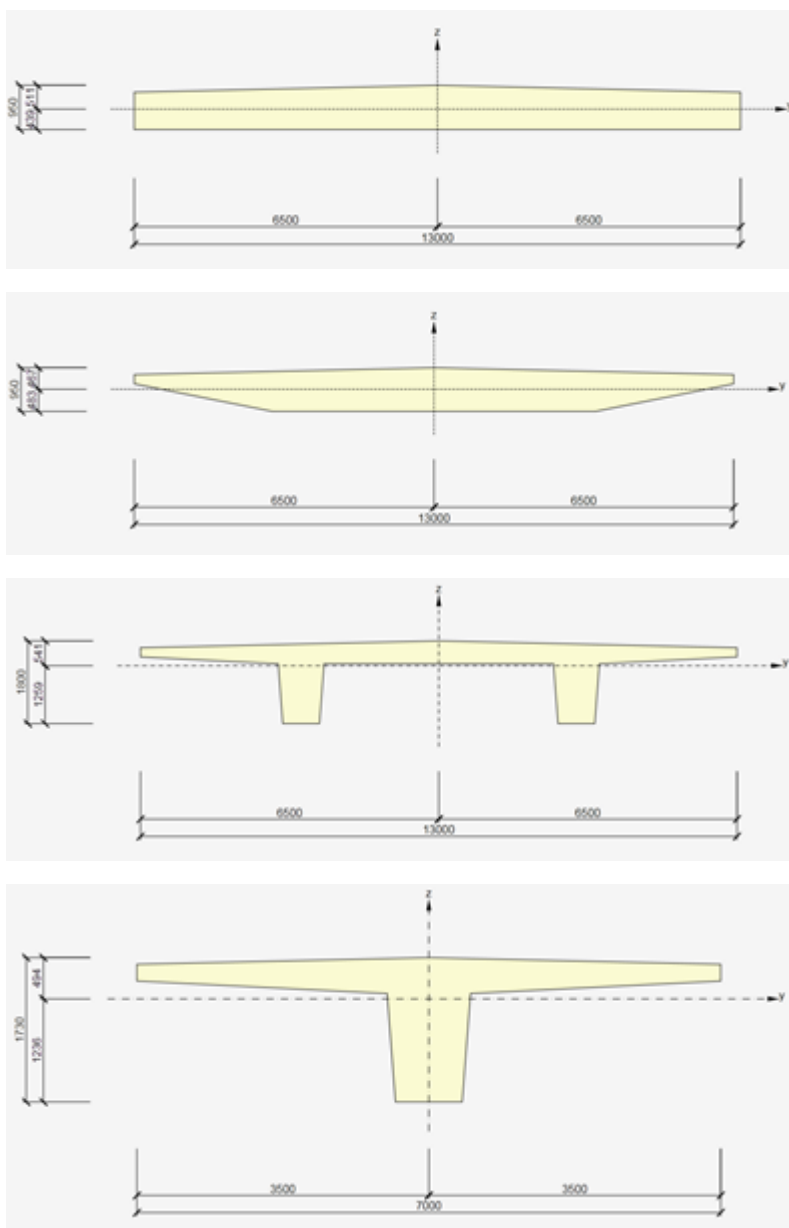

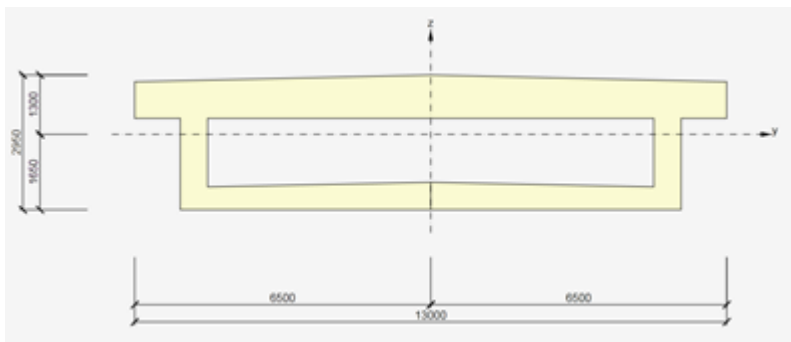
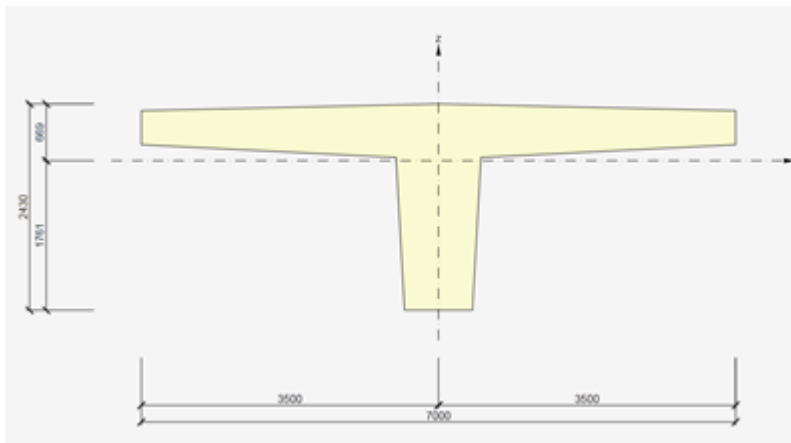
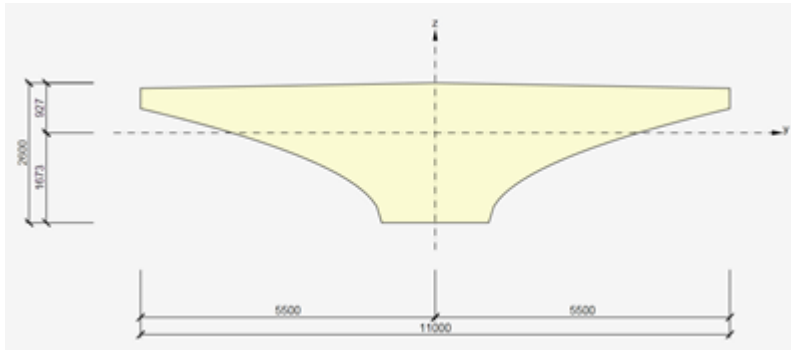
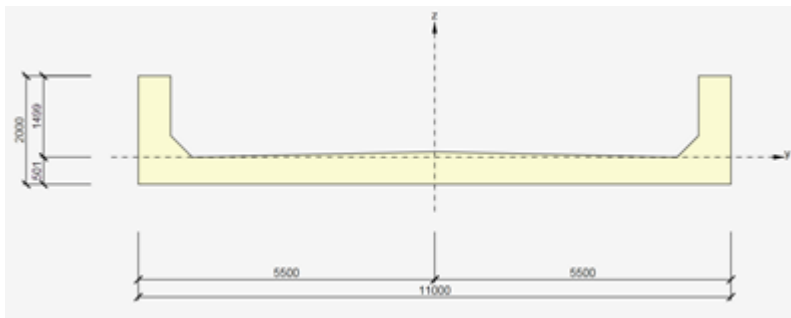

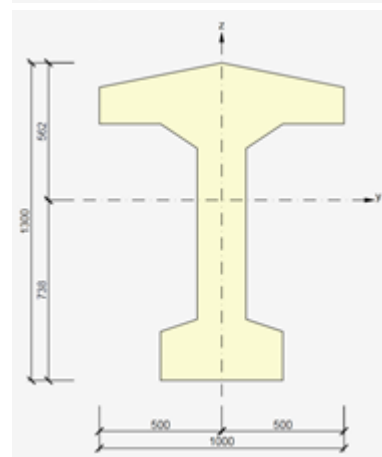
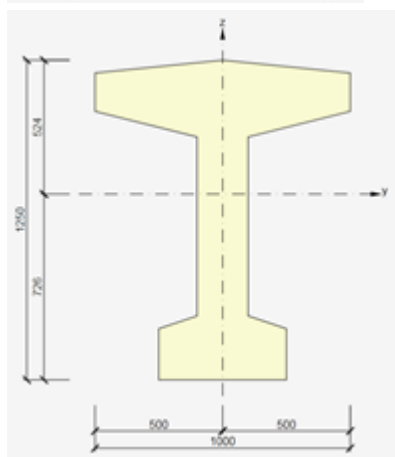
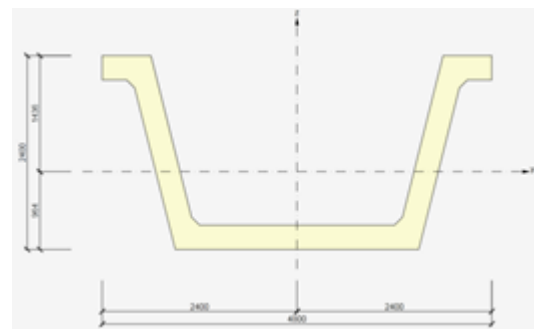
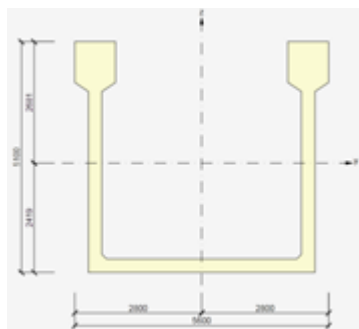
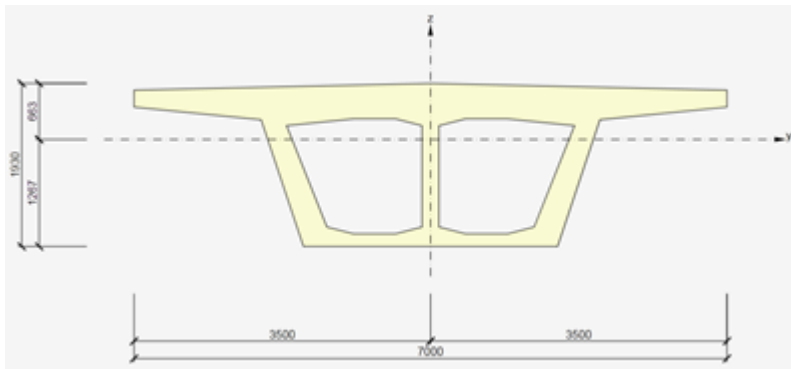
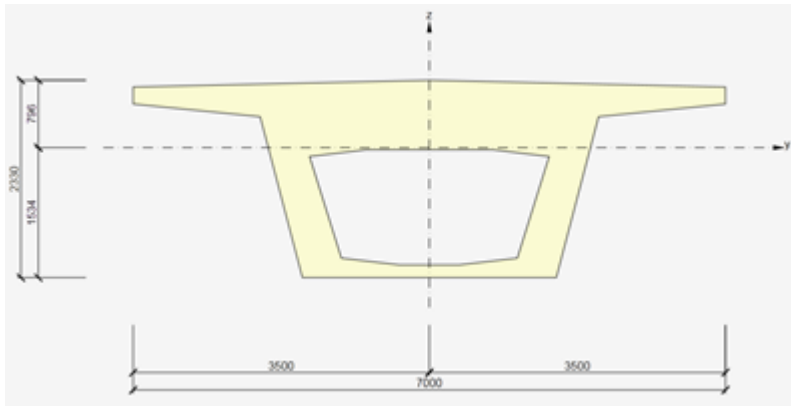

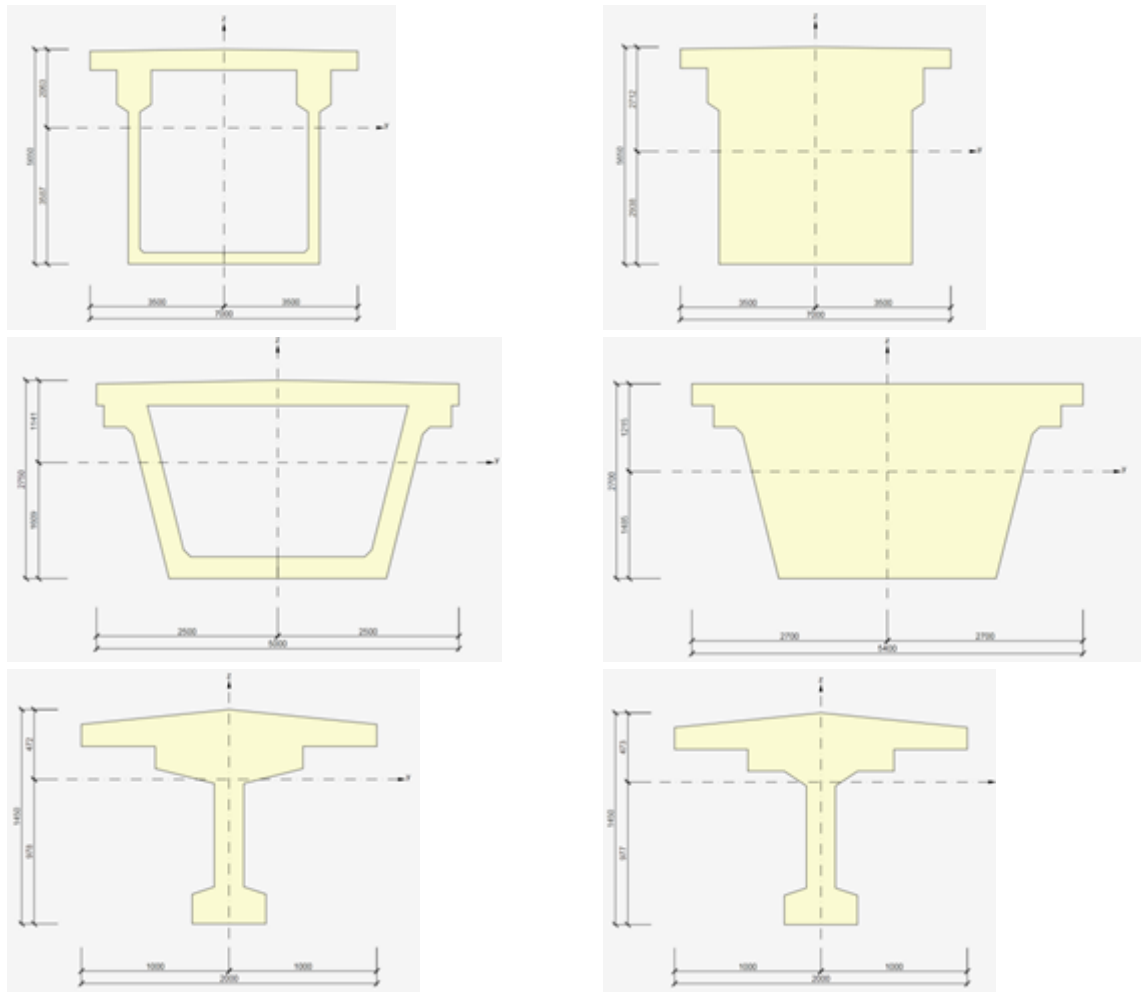

e) **general cross-sections** – import of cross-sections with one component only is supported. If general cross-section contains more components, only first one is imported. Number of openings is not limited.

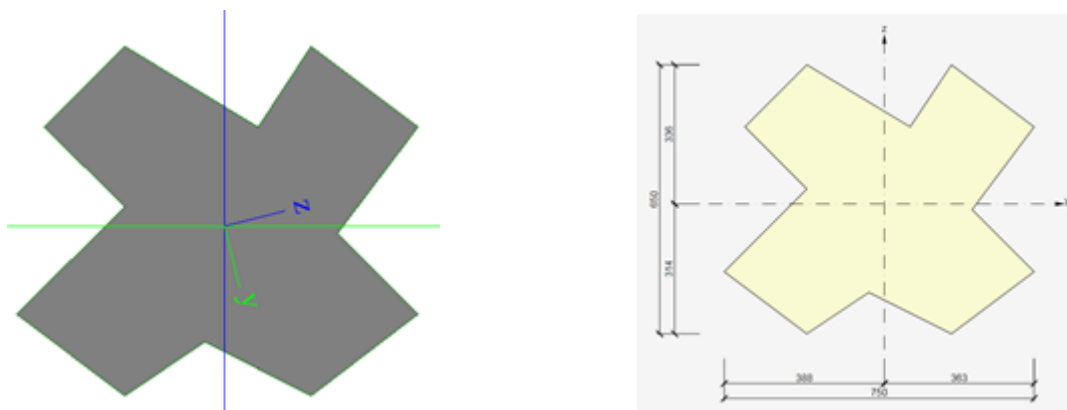

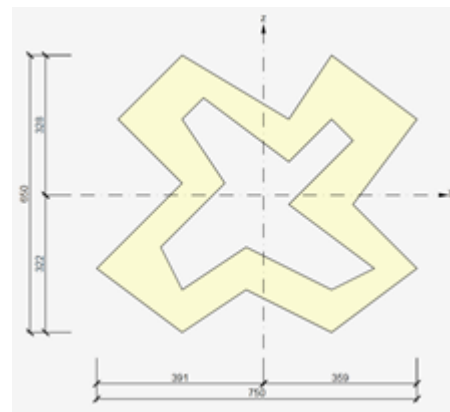
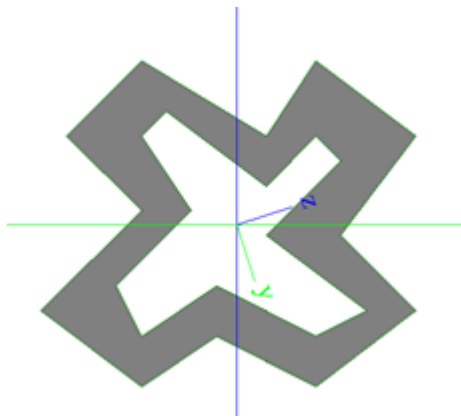

It is not possible to import cross-sections with curved edges, because curved edge is not described in XML file. Circular holes are not supported

Circular cross-section generated as general cross-section (consists of two arches) cannot be imported.

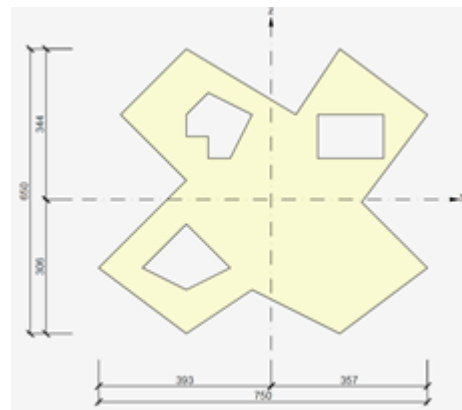
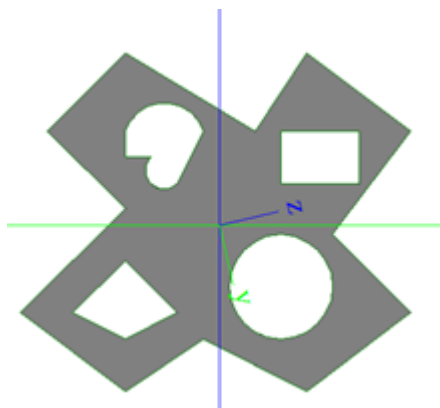

f) **numerical cross-sections** – import of numerical cross-sections is not supported.

Table of chapter Cross-section must contain following columns:

- **Name**
- **Type** – type of cross-section
- Items from folder **Parameters**
- **Catalog ID** – number of catalogue for catalogue cross-sections
- **CatalogItem** – number of cross-section in catalogue
- Items from folder **Fibre** – for cross-sections not supported directly in IDEA RCS, to create general cross-section using fibres
- Items from folder **Elements** – items for general cross-sections, including general cross-sections, openings and stages

It is recommended to set item **Filter** to **Used** in properties of table **Cross-sections** to export only cross-sections assigned to beams.

17.3.2 Materials

Only concrete is imported into IDEA RCS, reinforced steel is not imported.

Value of parameter '**Calculated dependent values**' is important during import of concrete material. It determines, whether material characteristics correspond to national code or material characteristic were edited by user.

If only code materials were used in imported project, table **Materials** must contain following columns:

- **Name**
- **Material type**
- **Calculated depended values**
- **Characteristic compressive cylinder strength fck(28)**

The imported material is compared with materials in IDEA RCS materials according those parameters. If no material is found with matching name and fck(28), new one is created. But then table **Materials** must contain more columns:

- **Thermal expansion**
- **Unit mass**
- **E modulus** or **Modul E** – acc. to version of SCIA Engineer
- **G modulus**
- **Poisson coeff.**
- **Stone diameter (dg)**
- **Cement class**
- **Characteristic compressive cylinder strength fck(28)**
- **Mean compressive strength fcm(28)**
- **Mean tensile strength fctm(28)**
- **fctk 0,05(28)**
- **fctk 0,95(28)**
- **Strain at reaching maximum strength eps c2**
- **Ultimate strain eps cu2**
- **Strain at reaching maximum strength eps c3**
- **Ultimate strain eps cu3**
- **n**
- **Type of aggregate**
- **Measured values of mean compressive strength (influence of ageing)**
- **Type of diagram**

It is recommended to set item **Filter** to **Used** in properties of table **Materials** to export only materials assigned to cross-sections.

17.3.3 Members 1D

Table of chapter **Members** must contain columns:

- **Name**
- **Cross-section**
- **Type** – type of member – for member type in IDEA RCS
- **Length** – length of member

For Rib member type must contain also columns

- **Alignment**
- **Shapeofrib**
- **Effectivewidth**
- Folder **Reference table**
Columns for effective width for check (the same columns twice, because first two columns are for width input by value, second for input by multiple of slab height)
- **forcheck**
- **widthright**
- **forcheck**
- **widthright**

Import of member of type Rib is limited to rectangular cross-section. Such cross-section is imported into IDEA RCS as T shape, L shape or X shape.

If first member in SCIA Engineer project is a non-rib, it is not possible to add folder **Reference table** into **Members 1D table**. Because of that data about corresponding slab are not exported into XML file, it is not possible to get height of slab and substitutive cross-section cannot be created in IDEA RCS.

In such case warning is displayed during import and substitutive cross-section is created using height of first slab in XML file or with default height 200 mm

It is possible to set item Selection in table Members 1D to required selection of members, for which export is required. Selection of members can be set in properties of chapter **Internal forces on members** too.

17.3.4 Haunches

This table must be included into XML document only for structures which contain haunches.

Table of chapter **Haunches** must contain following columns:

- Folder **Reference table**
- **Coord. definition**
- **Length x**
- **Position**
- **Cross-section**
- Folder **Parameters**

17.3.5 Arbitrary members

This table must be included into XML document only for structures which contain arbitrary members.

Table of chapter **Arbitrary members** must contain following columns:

- Folder **Reference table**
- **Coord. definition**
- **Cross-section**
- Folder **Spans table**

Warning – if the field of arbitrary member contains parametric haunch, only first parameter of cross-section in field is exported. It means, that when some field contains rectangular cross-section with parameters H (height) and B (depth), only value of H parameter is exported into XML file and value of

B parameter is constant over the whole length of field. When using haunch cross-sections, it is recommended to use two different sections at the beginning and at the ending of field.

17.3.6 2D members

This table must be included into XML document only for structures, which contain ribs.

Table of chapter **2D members** must contain columns:

- **Name**
- **Thickness**
- **Material**
- **Type** – determines type of member generated in IDEA RCS according to type of 2D member in SCIA Engineer – for type Wall in SCIA Engineer type Shell-Wall is generated in IDEA RCS, for types Slab or Shell in SCIA Engineer member with type Shell-Slab is generated in IDEA RCS.

17.3.7 Load cases

This table is required for generation of loads extremes content in IDEA RCS.

Table **Load cases** must contain columns:

- **Name** – name of load case

17.3.8 Combinations

Table is required for generation of loads extremes in IDEA RCS.

Table **Combinations** must contain columns:

- **Name** – name of combination
- **Type** – type of combination, which determines type of combination generated in IDEA RCS

17.3.9 Named selections

Named selections defined in SCIA Engineer can be used for automatic generation of representative members in IDEA RCS.

All sections in IDEA RCS, which were generated from members in named selection, have assigned the same (representative) member

Table **Named selections** must contain columns:

- **Name** – named selection name. This name is used as name of member data in IDEA RCS
- **Selected objects (GUID.ID)** – contains content of named selection

Following rules has to be followed:

- All members in named selection must have identical parameters. Members must have identical cross-section and length and must be of the same type (column, beam, rib). If the members contain haunch or arbitrary section, this data must be in named selection identical too.
- One member can be only in one named selection.

17.3.10 General rules used when converting internal forces to loads extremes in IDEA RCS

XML document may contain more chapters Internal forces on member or Members 2D – internal forces. Each chapter should represent other type of combination to import forces into IDEA RCS.

To import content of all combinations required in IDEA RCS, XML document should contain three chapters Internal forces on members (or Members 2D – internal forces). Particular chapters should have assigned following combinations:

- One (ULS combination
- One SLS-Quasi permanent combination
- One SLS-Characteristics permanent combination

If results are exported for load cases, result classes or more combinations of the same type, it is not possible to assign type of combination from SCIA Engineer to type of combination in IDEA RCS automatically. In this case dialog appears, in which exported results can be assigned to IDEA RCS combinations.

General rules for possible assignment of imported results to combinations:

- ULS combination in IDEA RCS – load cases, result classes, ULS combinations from SCIA Engineer
- SLS characteristics combination in IDEA RCS – SLS combinations except SLS EN Quasi-permanent from SCIA Engineer
- SLS Quasi-permanent in IDEA RCS – SLS combination except SLS EN Characteristics

More combinations from SCIA Engineer can be assigned to one combination type in IDEA RCS. Results from all assigned combinations are imported than.

If XML document contains more results – e.g. for ULS, SLS Quasi-permanent and SLS-Characteristics, the same selection of members and mode of extreme evaluation should be set for all of them. If selections and extreme evaluation are not the same, results from differing combinations are not imported.

Example of generated sections in IDA Concrete according to settings in XML document

- one chapter with results on member for combination ULS with results on member B1 in positions 0 and 10
- second chapter with results on member for combination SLS Characteristics with results on member B1 in positions 0 and 4
- third chapter with results for combination SLS Quasi-Permanent and results on member B, positions 0 and 4

For such defined result chapters following sections are generated in IDEA RCS:

- B1 in position 0, forces are imported for ULS and SLS Characteristics. Forces for SLS Quasi-permanent are zero.
- B1 in position 4, forces are imported only for SLS Characteristics
- B1 in position 10, forces are imported only for ULS
- B2 in position 0, forces are imported only for SLS Quasi-permanent
- B2 in position 4, forces are imported only for SLS Quasi-permanent

Generation of loads extremes for one section works in similar way. If more results are found for one combination in one position on member, the required number of loads extremes is generated

Example:

- 4 result tables are present in XML document with identical selection of members, identical section, following results are on member B1 in position 0:

- ULS – for combination C01/1, C01/2
- SLS Characteristics – for combination C02/1, C02/2, C02/3, C02/4
- SLS Quasi-permanent – for combination C03/1, C03/2, C03/3
- LC1 – load case
- IDEA RCS generates section with 4 loads extremes, with combinations in order for ULS, SLS Characteristics, SLS Quasi-permanent:
 - C01/1, C02/1, C03/1
 - C01/2, C02/2, C03/2
 - LC1/1, C02/3, C03/3
 - xxx, C02/4, xxx – where xxx means, that forces in this combination are zero

Example of 2D sections generation in IDEA RCS according to settings in XML document:

- XML file contains 3 chapters with results on slabs, property **Extreme** of result tables is set to No (all results are exported)
- The first chapter for combination C01 for ULS has property **Position** set to **In centre**, it means that for each finite element two values are exported – minimal and maximal value of combination
- The second chapter for combination C02 for SLS Characteristics has property **Position** set to **In nodes, no average** – it means that for each finite element 8 (or 6 for triangular finite element) values are exported, 2 values (minimum and maximum) for each node (4 nodes on rectangular, 3 on triangular finite element)
- The third chapter for combination C03 for SLS Quasi-permanent has property **Position** set to **In nodes, average**. Table does not contain numbers of finite elements, but numbers of nodes, e.g. for node N1 table contains two values.
- IDEA RCS generates one section with 8 loads extremes for finite element
 - First two loads extremes contain results for ULS combination imported from combination C01 and for SLS Characteristics imported from C0.
 - There are no results for ULS in following extremes, so only forces for SLS Characteristics are imported.
 - Because results for SLS Quasi-permanent were exported for position In nodes, average, it is not possible import values for this combination into section for finite element.
- IDEA RCS than generates section for node N1
 - Into section generated for node cannot be imported results, which were exported for finite element. So it this example results from combinations C01 and C02 cannot be imported.
 - Two loads extremes are generated for node N1. Only values of forces for SLS Quasi-permanent are imported from combination C03, other load effects are zero.

17.3.11 Internal forces on members

Following options can be set in properties of chapter **Internal forces on members**:

- **Selection** – set selection of members, for which results are exported.
Remark: An intersection of selections in chapters Members and Internal forces is performed during export. It means that if there are members B1 and B2 selected in chapter Members and

B2 and B3 are selected in chapter Internal forces on members, only member B2 is imported into IDEA RCS.

- **Type of loads** – set type of evaluated load
- **Rib** – has to be checked for export of ribs
- **Values** – internal forces to be exported.
Remark: if e.g. component My is selected in the list of internal forces, it does not mean that only My is exported. This setting affects only drawing of internal forces, but all result components are exported. But if item More components is set and for this item only component My is selected, really only My is exported and other components of internal forces are zero after import into IDEA RCS.
- **System** – must be set to LCS, to have the same convention of internal forces in SCIA Engineer and IDEA RCS.
- **Extreme** – set mode of extremes evaluation. This mode affects number of generated sections in IDEA RCS.

17.3.12 Member 2D – internal forces

Table with internal forces on members 2D must contain following columns:

- **Member** – name of slab
- **Case** – name of evaluated case/combi/result class
- **Section**
- **dx**
- **Node**
- **X, Y, Z**
- **Elem** – number of finite element
- **mx, my, mxy, vx, vy, nx, ny, nxy** – particular components of internal forces on slab

Following options can be set in properties of chapter 2D member - internal forces:

- **System : Local** – ensures, that forces and their directions corresponds with directions of slab. It is possible to use any direction of forces, but it must be kept in mind, for which direction forces were exported. The original direction of forces cannot be traced in IDEA RCS.
- **Type forces** – must be set to **Basic magnitudes**.
- **Envelope** – has no sense in XML document, minimal and maximal values are always exported.
- **Extreme** – set mode of extremes evaluation. This mode affects number of generated sections in IDEA RCS.
- **Location** – set mode of internal forces evaluation. It is possible to evaluate forces for different locations, internal forces are exported to IDEA RCS according to current setting of **Location**. In general it should be ensured, that when exporting more result chapters together (e.g. one slab, but one combination ULS and all SLSL), **Location** should be set to be the same for all result chapters. It is not required, but if it is not kept, results can be mismatched. When export to XML is finished, it is not possible to determine the original setting of Location property. It is only possible to distinguish between results averaged to nodes and other results, because results table contains column Node and for other setting of **Location** the table contains column Element.