

User manual

USB/SD MEDIA PLAYER

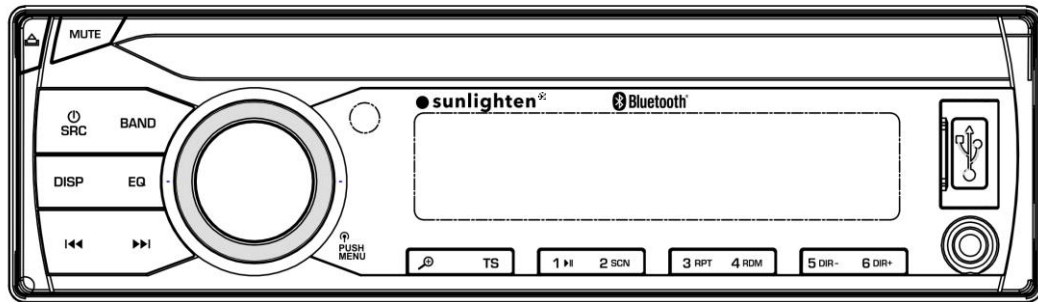

- **PLL Synthesizer Stereo Radio**
- **MP3/WMA Player**
- **Full Detachable Panel**
- **USB/ SD Interface**
- **3.5mm Jack Input**
- **Bluetooth Connectivity and Troubleshooting**
- **A.R.T. Activation**
- **Specifications**
- **Troubleshooting**

Please read the instructions carefully before operating.

Installation

Read carefully prior to installation

1. Make sure to connect other wires before power connection.
2. To avoid short circuit, please make sure all exposed wiring is insulated.
3. Please fix all wires after installation.
4. Incorrect connection may cause malfunction or damage to the electrical system; make sure all connections are made according to instruction.

Installation Steps

REMOVE THE UNIT

1. Detach the front panel.
2. Take out the outer trim frame.

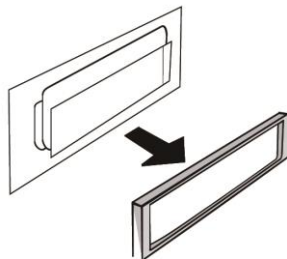

3. Insert the keys supplied on both sides of the unit until they click. Remove the unit from the dashboard by pulling the keys.

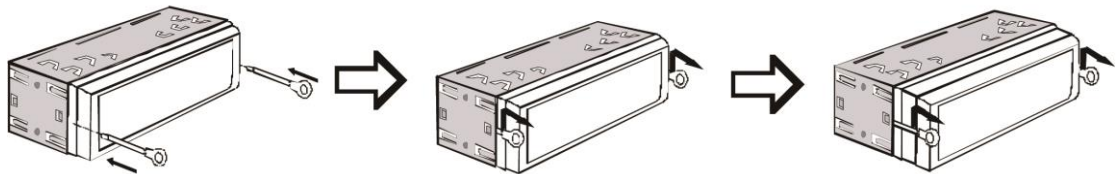

WIRING CONNECTION

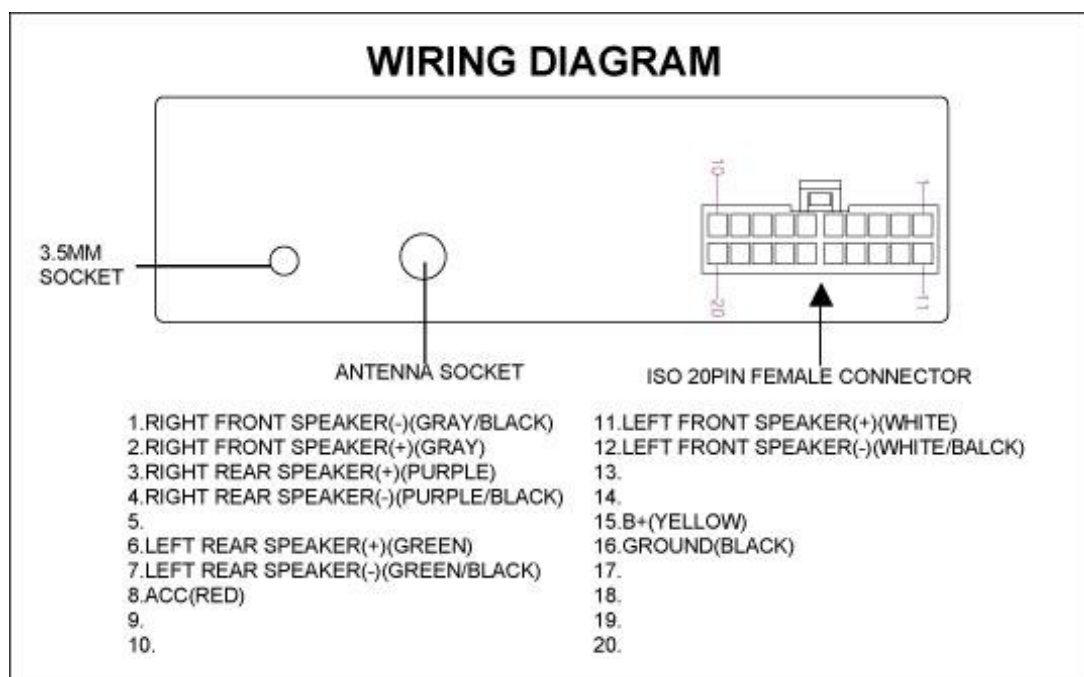

LOCATION OF CONTROLS

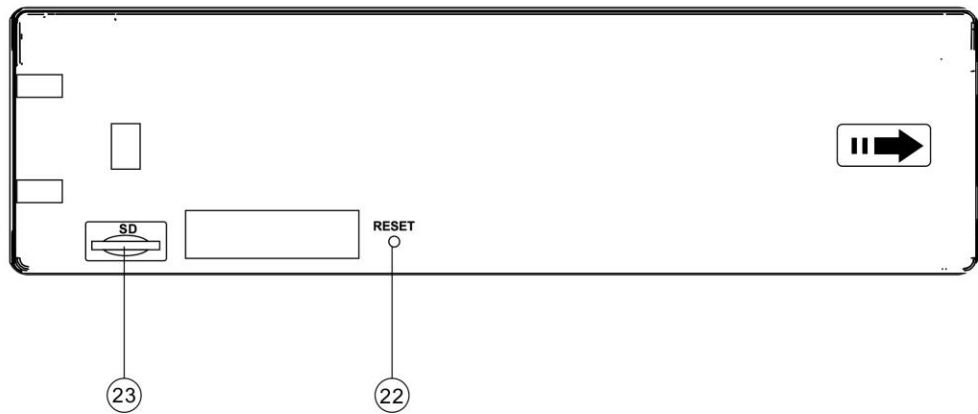
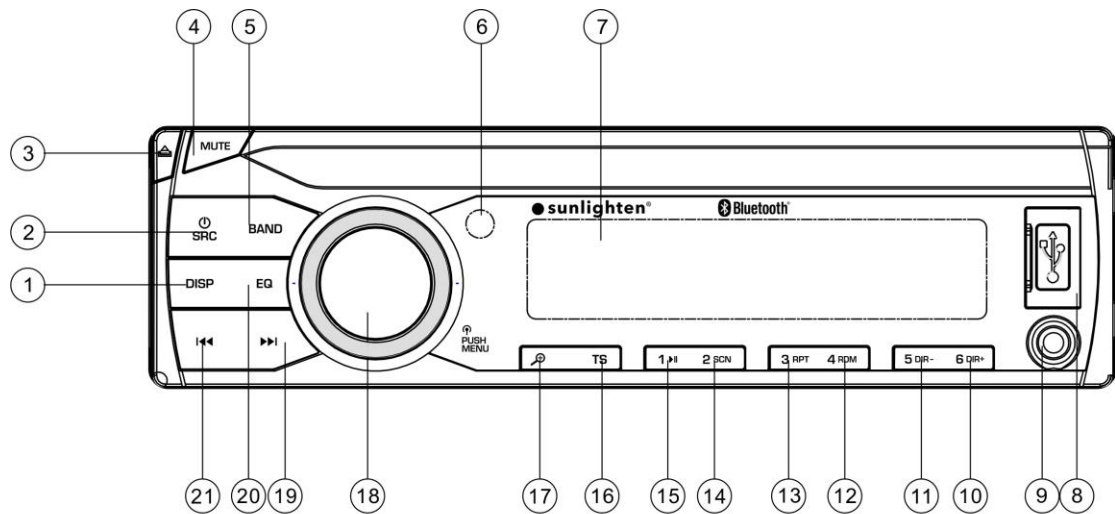



- | | |
|---|---|
| <ol style="list-style-type: none"> 1. "DISP" button. 2. "SRC"/ power button. 3. "▲" (panel release) button. 4. "MUTE" button. 5. "BAND/⌂" button." 6. IR SENSOR. 7. LCD " display. 8. USB port 9. "AUX IN" jack. 10. "6 DIR+" button. 11. "5 DIR-" button. 12. "4 RDM" button | <ol style="list-style-type: none"> 13. "3 RPT " button. 14. "2 SCN " button. 15. "1 > " button. 16. "TS" button. 17. "🔍" MP3 search button 18. Volume button/MENU button 19. "▶▶"(SEEK UP) button. 20. "EQ " button. 21. "◀◀"(SEEK DOWN) button. 22. RESET button. 23. TF card slot. |
|---|---|

KEY FUNCTIONS

Key functions

Button	Action	RADIO	USB/SD	BT	F-AUX/R-AUX
1/▶	Short press	Recall M1 station	pause/play/ Search:1	pause/play/	/
	Long press	Store station to M1	/	/	/
2/SCN	Short press	Recall M2 station	SCN on/off / Search:2		/
	Long press	Store station to M2	/	/	/
3/RPT	Short press	Recall M3 station	RPT FLOD/ONE/ ALL/ Search:3		/
	Long press	Store station to M3	/	/	/
4/RDM	Short press	Recall M4 station	RDM on/off / Search:4		/
	Long press	Store station to M4	/	/	/
5/DIR-	Short press	Recall M5 station	DIR- /Search:5		/
	Long press	Store station to M5	-10	/	/
6/DIR+	Short press	Recall M6 station	DIR+ /Search:6		/
	Long press	Store station to M6	+10	/	/
TS	Short press	Preset scan stations of 1~6	/		/
	Long press	Auto store station to 1~6 of FM3	/	/	/
EQ	Short press	FLAT/POP/ ROCK/CLAS/ EQ OFF	FLAT/POP/ ROCK/CLAS/EQ OFF / Search:7	FLAT/POP/ ROCK/CLAS/EQ OFF	FLAT/POP/ ROCK/CLAS/ EQ EQ OFF
	Long press	XBASS on/off	XBASS on/off	XBASS on/off	XBASS on/off
DISP	Short press	CLK-PS-PTY- FREQ	play time->ID3 ID3->play time / Search:0	show clock	show clock
	Long press	clock setting	1'st: Show clock 2'nd: clock setting	clock setting	clock setting

KEY FUNCTIONS

	Short press	/	song searching	/	/
	Long press	/	/	/	/
	Short press	seek down	Previous/ Search:8	previous	/
	Long press	Manual turning down	Fast Reverse	/	/
	Short press	seek up	Next/ Search:9	next	/
	Long press	Manual turning up	Fast Forward	/	/
/SRC	Short press	power on/ source change	power on/ source change	power on/ source change	power on/ source change
	Long press	power off	power off	power off	power off
BAND	Short press	FM1-FM2-FM3- AM1-AM2	/	/	/
	Long press	/	/	/	/
VOL	Rotary	Volume +/-	Volume +/- / Search:0-9999	Volume +/-	Volume +/-
MENU (push VOL)	Short press	BASS/TRE/BAL/ART /EQ/XBASS/BEEP/D X/ STEREO/ CLOCK/AREA	BASS/TRE/BAL/ART /EQ/XBASS/BEEP/D X/ STEREO/ CLOCK/AREA	BASS/TRE/BAL/ART /EQ/XBASS/BEEP/D X/ STEREO/ CLOCK/AREA	BASS/TRE/BAL/ART/ EQ/XBASS/BEEP/DX / STEREO/ CLOCK/AREA
	Long press	(AF)/TA/TAVOL/ (REG)	(AF)/TA/TAVOL/ (REG)	(AF)/TA/TAVOL/ (REG)	(AF)/TA/TAVOL/ (REG)

OPERATION

BASIC OPERATION

Click the SRC button to activate the stereo. Default is FM radio. Once powered on, quick presses of the SRC button will cycle through the various audio sources. Pressing and holding the SRC button will power the stereo unit off.

Menu setting

Repeatedly press **MENU** button for audio menu: BASS-TRE(Treble)-BAL(Balance)-ART(on/off)-EQ(flat/pop/rock/clas/off)-XBASS(on/off)-BEEP(on/off)-DX(LOC)-STEREO(MONO)-CLOCK(12/24)-AREA(EUR/USA/LAT)

STEREO/MONO:

STEREO: Receiving FM stereo signal.

MONO: Change to monochrome. When the signal is not good. Changing it to MONO mode will reduce the noise.

Clock setting

(1) Manual setting:

Press and hold **DISP** button for 2 seconds. The hour of the time will be flashing. Press **▶▶ / ◀◀** button (or rotating the audio knob) to set the hour. Press **DISP** button shortly to change to minute. Also use **▶▶ / ◀◀** button (or rotating the audio knob) to set the correct minute. After that press **DISP** button to confirm.

AUX function

The unit has two input ports with AUX 3.5mm jacks. It can be connected to a portable audio player through the AUX IN jack. Press **SRC** button to switch to F-AUX/R-AUX mode when inserting an audio source to the unit.

RESET function

The RESET button is to be activated if the radio does not turn on or if having issues. Hold the reset button down for five seconds in order to reset.

Note: When **RESET** button is pressed. All the memory will be lost.

RADIO OPERATION

Tune a radio station

Press **SRC** button to select radio mode. Then press **BAND** button to select a band. Shortly press **▶▶ / ◀◀** button to receive the desired radio station. Press and hold **▶▶ / ◀◀** button for manual tuning the frequency.

OPERATION

Preset Scan stations:

Automatic

Press **TS** button for two seconds to scan and store stations. Press **TS** button to scan the preset stations stored in 1-6 of band 1-3.

Manual

To store a station, press one of the preset buttons (1-6) for two seconds. The current station will then save to that number. Press the preset buttons (1-6) to listen to the station saved in the corresponding preset button.

USB/SD OPERATION

When a USB driver/SD card is inserted into the unit, the unit will play the MPS/WMA file automatically. If a USB/SD card is already inserted in the unit, keep pressing **SRC** button shortly until the USB/SD mode display appears.

Select file:

Press **▶▶/◀◀** button to select the following/previous file. Hold **▶▶/◀◀** button to fast forward or fast reverse.

Play/pause function:

Press **▶||** button to pause playing. Press it again to resume play.

Scan function:

Press **SCN** button to turn on/off the SCAN function.

SCN on: playing first 10 seconds of each file.

SCN off: Cancel SCAN function.

Repeat function:

Press **RPT** button to select one of below repeat way.

Repeat folder: repeat all the file in the folder.

Repeat one: always repeat the same file.

Repeat all: Repeat all file.(default)

Random function:

Press **RDM** button to turn on/off the random function.

RDM on: To play all files in random order.

RDM off: Cancel random function.

Directory up/down function:

Press **DIR- /DIR+** button to select previous directory or next directory.

+10/-10 file function:



Press and hold **DIR- /DIR+** button for +10/-10 file function.

OPERATION



File search

There are 2 kind of song search way: DIR search and NUM serach. Press  button to select them:

1) DIR search:

Press  button one time. It shows "DIR SCH". Rotating VOL knob to select the folder then press **VOL** knob into the folder. Rotating the VOL knob again to select the file. Then press **VOL** to confirm. The unit searches the selected song to play. (Press  button will back to previous folder.)

2) NUM serach:

Press  button twice times. It shows "NUM SCH". You can select the file by directly enter numeric buttons: 0~9 button(EQ=7, =8, =9,DISP=0). You also can rotating the VOL knob to select the numeric. If the file number was selected. The unit wait for VOL knob be pressed for seconds. The unit searches the file after few seconds even if the VOL knob is not pressed.

CAUTION

When there are important files in the USB device/TF card, do not connect it to the main unit to play. Because any wrong operation may cause files loss. And our company assumes no responsibility for this.

Bluetooth Connectivity

1. Activate the stereo by pressing the SRC button.
*Do not to hold the SRC button down as that is for deactivation.
2. Go to Bluetooth settings on the device you'd like to pair with the stereo.
From the "Available Devices" list, select "Sunlighten."
3. On the stereo, repeatedly press the SRC button to scroll through the audio sources. Stop when you see "BT" for Bluetooth.
*BT will not be visible for selection unless a device is ready to pair with the stereo.

Acoustic Resonance Therapy (A.R.T.) - optional add-on

How to activate A.R.T. on your stereo:

1. Power the unit on using the SRC button.
2. Press the volume knob until "ART OFF" displays and then turn the volume knob clockwise until the display reads, "ART ON."
3. Press the volume knob until "ART" displays on the left with two digits on the right.
4. Use the volume knob to adjust the intensity of the A.R.T. system.

SPECIFICATION

GENERAL

Power Supply Requirements	: DC 12 Volts, Negative Ground
Chassis Dimensions	: 178 (W) x 97 (D) x 50 (H)
Tone Controls	
- Bass (at 100 Hz)	: ±10 dB
- Treble (at 10 kHz)	: ±10 dB
Maximum Output Power	: 4x40 watts
Current Drain	: 10 Ampere (max.)

RADIO

FM

Frequency Coverage	87.5 to 108 MHz.
Sensitivity (S/N=30dB)	4µV
Stereo Separation	>25dB

MW

Frequency Coverage	522 to 1620 KHz
Sensitivity (S/N=20dB)	36 dBuV

TROUBLESHOOTING

mPulse Audio Troubleshooting with Stereo

If there is no audio from tablet but stereo is functioning, please check the following:

1. The stereo is set to "R-AUX" source - check back of stereo to ensure connection (lowest port)
2. The volume is turned up on the stereo
3. The volume is turned up on the application
4. The volume is turned up through the tablet itself. To do this, go to the "settings/set-up" tab, then click "Set-up your wireless connection." Next, scroll down and click on "Sound" and then "Volumes."

TROUBLESHOOTING

Bluetooth Troubleshooting

To start troubleshooting a Bluetooth connectivity issue, please complete the following steps:

1. Reset the stereo. To do this, first remove the faceplate by pressing the eject button near the mute button. On the body of the stereo, there is a pin hole with an arrow saying reset. Using a slender object (toothpick, paper clip, etc.), press and hold the reset button for 5-10 seconds. Then replace the faceplate.
2. Reboot the stereo and attempt the connection again. If this doesn't work, try step #3.
3. Test the stereo with another Bluetooth device.

Before going through the checklist, check wiring connection. If any of the problems persist afterwards, consult Sunlighten Customer Care @ 877.292.0020.

Symptom	Cause	Solution
No power.	No power to stereo or sauna.	Check sauna power circuit breaker. Otherwise, please call Sunlighten Customer Care at 877.292.0020. M-F, 9am-4pm CST.
	The fuse is blown.	Replace the fuse.
No sound.	Volume is in minimum	Adjust volume to a desired level.
	Wiring is not properly connected.	Check wiring connection on roof of sauna.
The operation keys do not work.	The built-in microcomputer is not operating properly due to noise.	Press the reset button.
The radio does not work. The radio station automatic selection does not work.	The antenna cable is not connected.	Insert the antenna cable firmly in back of stereo and check antenna connection on roof of sauna.
	The signals are too weak.	Select a station manually.