





mPulse® Power Box 6 Installation Guide

We're very excited you received your replacement power box and are eager to get your unit back up to optimal operation! This power box is designed with customer installation in mind and this guide will help you through that process while avoiding any potential pitfalls.





Labeling

The wiring connections of your power box are labeled with stickers of particular shapes and colors to help you classify them.

 Near Infrared (NIR): green sticker; semi-transparent connector; red and white wiring

 Heat: red sticker; solid white connector; black wiring

 Sensor (NTC): blue/dark purple sticker; solid white connector; red and white wiring

 Left Wall  Back Wall  Right Wall  Front Wall

Each wall is assigned a different shape. Walls are labeled with the viewpoint of facing the back wall inside the sauna. Colors correspond with different levels of power distributed to parts of the unit - power feeds, blue sensor or NTC feeds, and green near infrared feeds.

NOTE: The shapes of the blue, red, and green stickers may differ from what is listed in this document, but the color will not.

INSTALLATION



Step 1

Unplug the unit from the power source or flip the breaker for the dedicated circuit to the sauna. You may find the power box area more easily accessible if you also remove the bench. What follows can be done without bench removal, but is more efficient and comfortable with the added space.

mPulse Power Box 6 Installation Guide



To remove the bench, unmount the heater frames from the surrounding walls. Reach underneath, with your palms upward, and the bench will lift straight up from the supports mounted to the walls (for Discover and Empower cabins, you only need to remove the back-wall bench sections). You can then rotate the detached bench vertically and walk it backwards out of the sauna.

Step 2

The very last portions of the floor, under the bench and back against the wall, cover the power box. Unscrew the power box covers. The Phillips head screws will be located in the grooves between the floor boards. You will see the sections of the power box covers with a bisecting cut perpendicular to the wood slats. Remove all screws for all sections of the power box covers.

Step 3



Once exposed, remove the Phillips screws anchoring the power box to the ground - two on the long front edge and one on the right edge close to the back wall (as you are facing the back wall).

mPulse Power Box 6 Installation Guide

Step 4

Disconnect the power cord on the left edge of the power box. NOTE: The power cord is also anchored by a Phillips screw to the wood inside the base, immediately to the left of the power box.

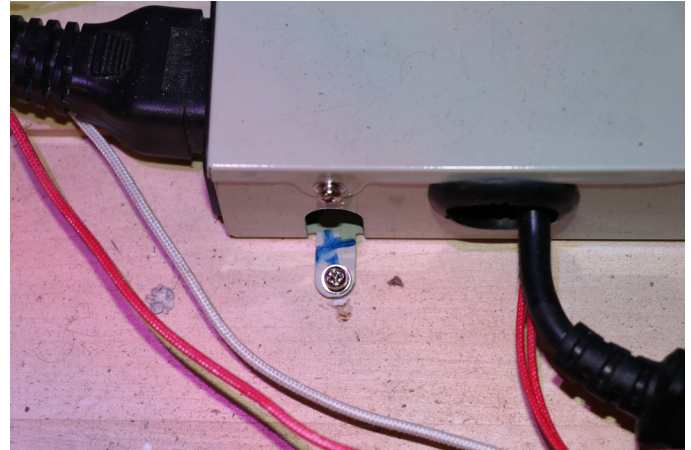
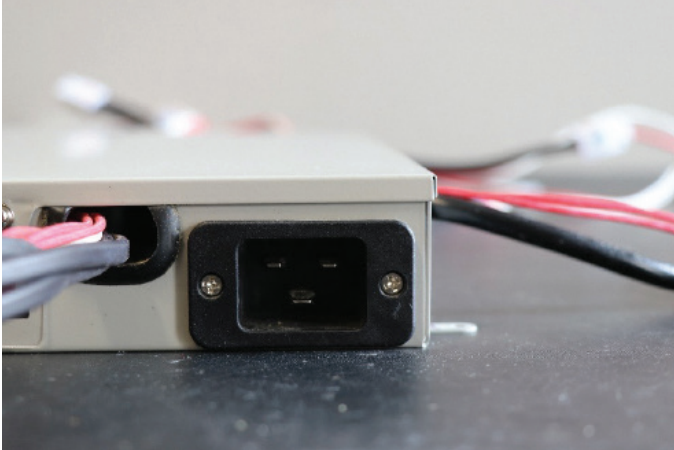

Step 5

We are now ready to begin disconnecting the power box from the wiring from the walls. Start with the left wall connections. These will both be labeled with a triangle. Disconnect the power feed, G1 ▲, from the wall feed, A1 ▲. Each connector has a lever on one side that you press to pull them apart.



Step 6

Disconnect the L sensor connector ▲, then disconnect the NIR connector ▲ if you have a Discover (4-person sauna) or Empower (5-person sauna). If you have an Aspire (1-person), Believe (2-person), or Conquer (3-person), you won't have a direct connection between the power box and the wall. The left wall will be split from the right side of the box. This will be disconnected in Step 8.

Finally, disconnect the main power cord on the left side from the power box. You may need to remove the Phillips screw anchoring the cord to the floor.

mPulse Power Box 6 Installation Guide

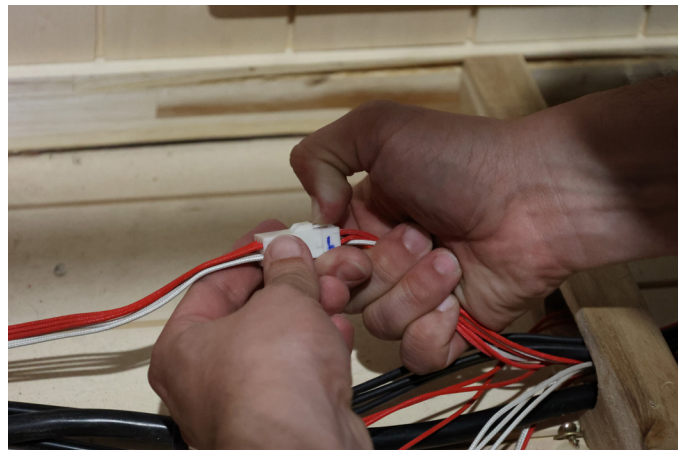

Step 7



On the front facing side, the left port will house two connections (only applicable for saunas with floor heater(s) under the floor grate). If you do not have a floor heater, move to Step 7b.

- Disconnect thick black plug for the power to the floor heater
- Disconnect small white connector with red and white wiring

Step 7b

Move along the front edge to the right front port of wires. Disconnect the 4-pin flat G17 connector (red, white, black, and blue wires) from the corresponding connection, F18.

Disconnect the G30 power connector from the corresponding F20 connector.

The front wall sensor  will need to be disconnected from F8 (this step will not apply to Aspire (1-person saunas)). The front wall power feed  will be disconnected from F7 (this step will not apply to Aspire (1-person saunas)).

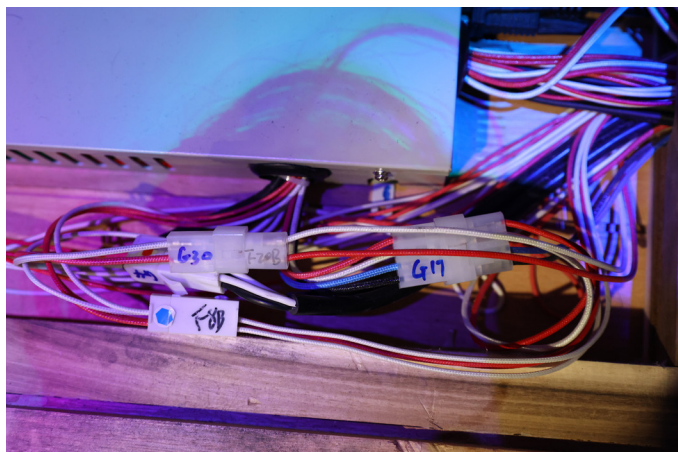



mPulse Power Box 6 Installation Guide

Step 8

Turn the corner to the first port of wires on the right edge of the power box and note that these wires pass through the wood support to the section to the immediate right of the power box in the floor. There will be a zip tie holding a bundle of wires between the two black boxes. Cut this zip tie and another in this section to the right, to allow for a better view of the connectors.

Disconnect the sensor connector (labeled R ) from the corresponding connector F11.

Depending upon which mPulse sauna you have, you'll find additional NIR wiring in one of the following configurations:

- Aspire (1-person sauna), it splits from the back wall to the left and right walls. This splitter (F19) will plug into the  connector on the right side, back port of the power box.
- Believe (2-person sauna) and Conquer (3-person sauna), it will split from the right wall to the left wall. This splitter will plug into the  connector on the right side, front port of the power box.
- Discover (4-person) and Empower (5-person) models, there is no splitting. The right wall NIR feed  will plug directly into F12.



mPulse Power Box 6 Installation Guide

Step 9

On the right side of the power box, front port, disconnect the 3-pin G41 connector ● (blue circle) from the F16 harness. Disconnect both the G42 and G43 2-pin connectors ● (purple circle) from the paired transformer connectors (black box) located closer to the back wall.



Step 10

Move back to the right edge of the power box and disconnect the back wall wires: the G2 power ■ cable from the B1 ■ connector, the sensor cable from the B5 sensor connector, and the G31 NIR connector ■ from the B6 connector ■. On the Aspire (1-person sauna), this will not be applicable. The power box side will plug into F19 as described above in step 8.



Congratulations! All connections will now be separated for removal of the power box. To install your replacement power box, you can reverse the same steps making the connections described above.

Please see the diagrams on the next page for which connections to pair as a reference.

mPulse Power Box 6 Installation Guide

Aspire
(1-person):
Top diagram

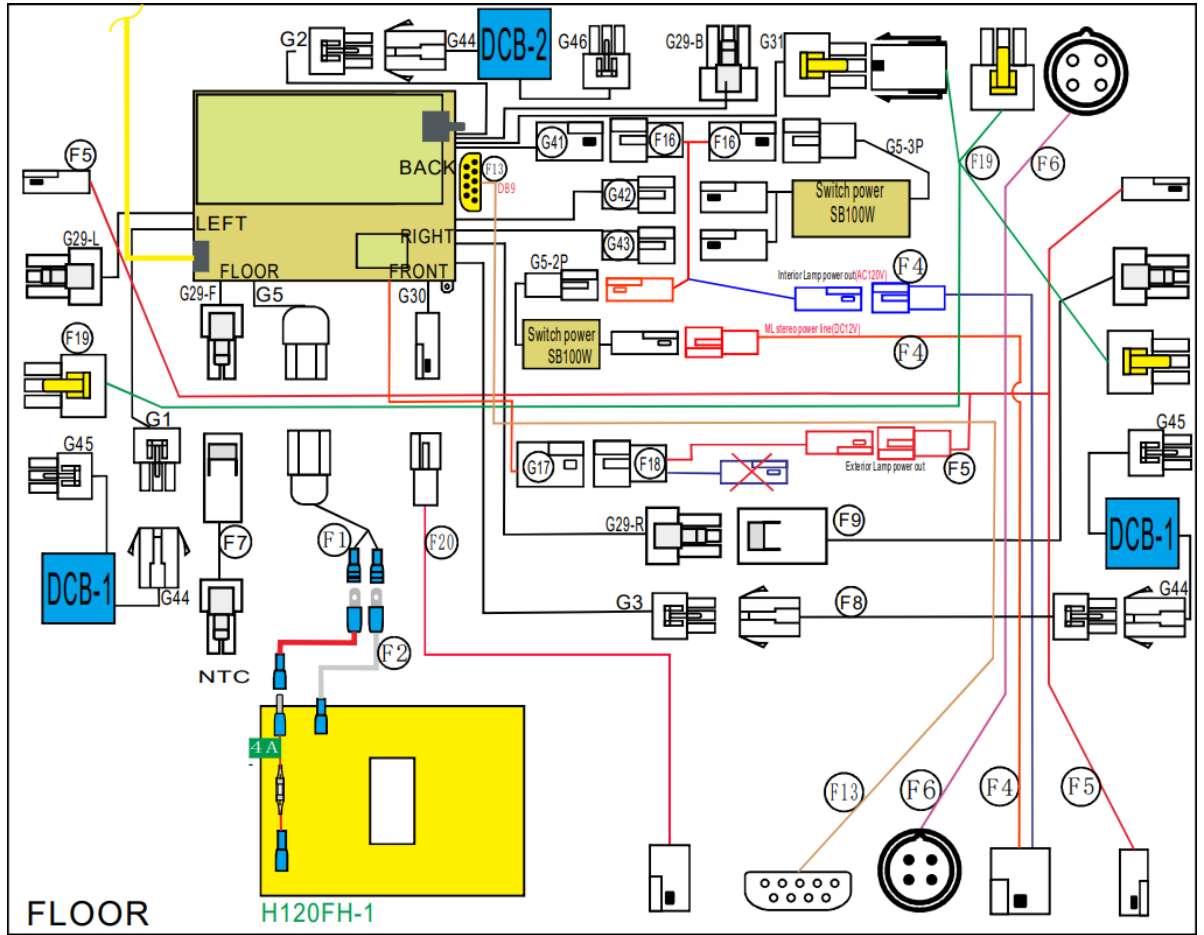

Believe/
Conquer
(2/3-person):
Bottom diagram

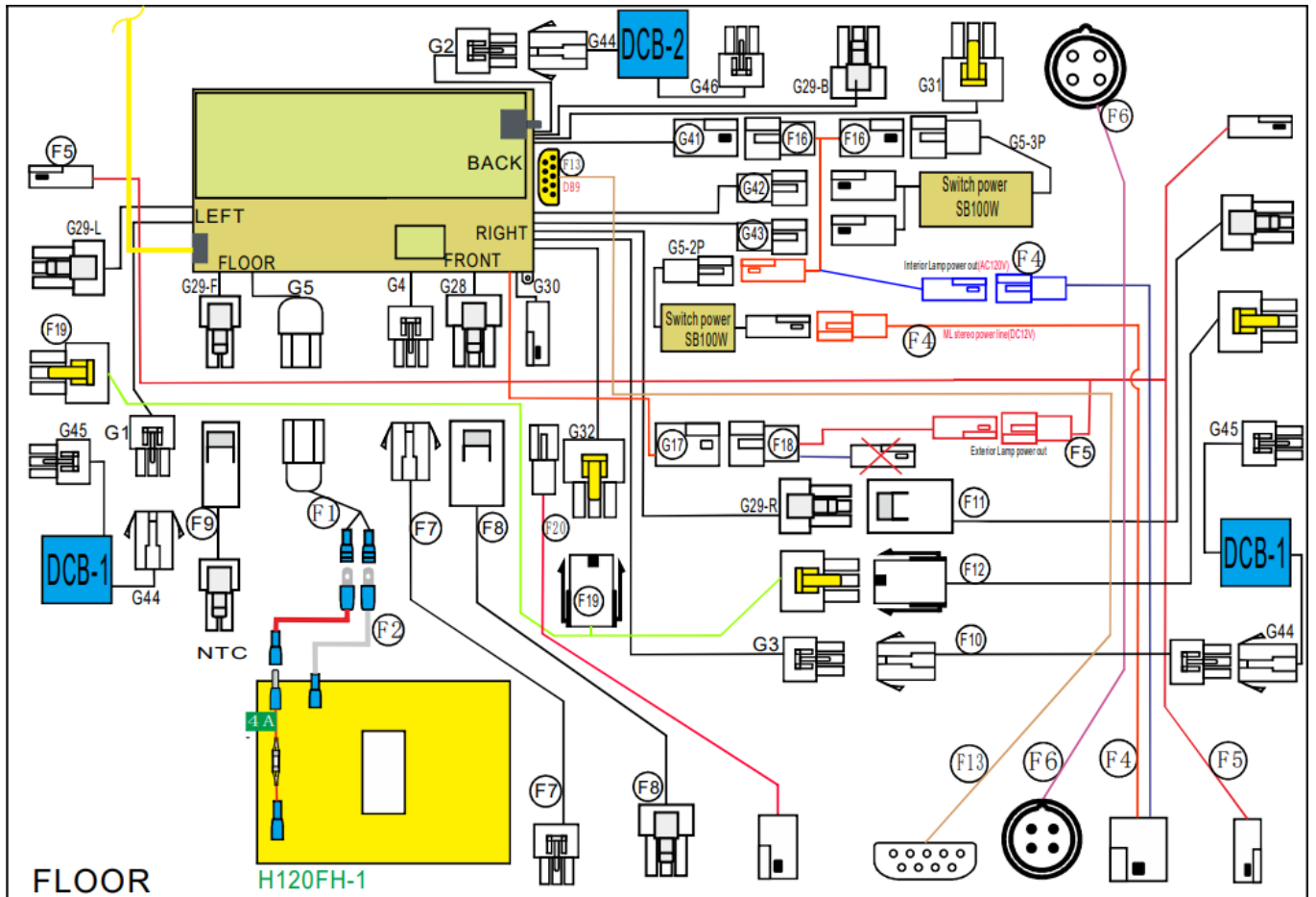

mPulse Power Box 6 Installation Guide

Discover/Empower
(4/5-person)

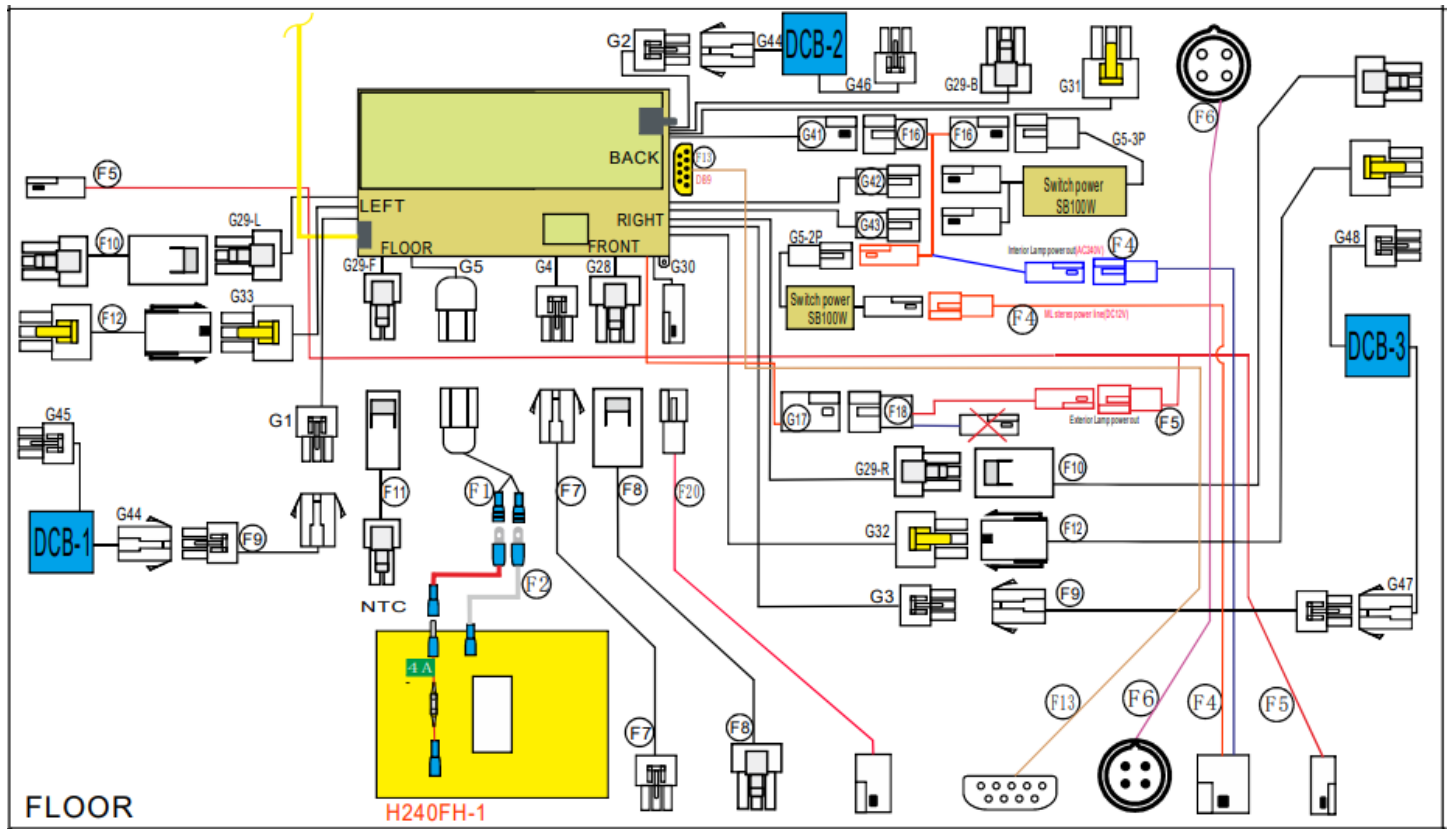

If you have any questions, you can contact us in the following ways:

Phone: 1-877-292-0020

Live Chat on our website

View FAQs: www.sunlighten.com/customer-service