



CUSTOM INFRARED SAUNA
INSTALLATION MANUAL

VERSION 08082022





INSTALLATION MANUAL
VERSION 08082022

TABLE OF CONTENTS

Custom Infrared Sauna Inventory	3
Lumber and Hardware	6
Installation	11
Circuit Wiring	20
Sauna Operation	22
Troubleshooting	23
Health and Safety	24
Warranty	25

CUSTOM INFRARED SAUNA INVENTORY

SUNLIGHTEN'S CUSTOM INFRARED SAUNA INSTALLATION INCLUDES:

- Sunlighten's patented far infrared (FIR) SoloCarbon® heater panels
- Premium eucalyptus or basswood heater cabinetry
- Premium eucalyptus or basswood tongue-and-groove sauna siding
- Premium eucalyptus or basswood bench slatting and wooden supports
- Premium eucalyptus or basswood wood trim
- Electronic power and control boards with subsequent peripherals

SUNLIGHTEN SAUNA DESIGN DOCUMENTATION INCLUDES:

- Floor plan views
- Elevation plan views
- Bench and supports detailing views
- Heater cabinetry detail views
- Tailored cut lists
- Bill of materials (BOM)
- Bill of quantities (BOQ) will be provided upon request
- Architectural visualization(s) (per request) is issued upon deposit

Product	Part Number (#)
Sunlighten SoloCarbon heater panel	LH-B 120
Sunlighten control board	SICPv2
Sunlighten power control board	SB5
Power control cable	J1-P4

ELECTRONIC EQUIPMENT INCLUDES:

- Sunlighten patented FIR SoloCarbon heater panels, providing therapeutic light and heat to the sauna
- Infrared sauna control panel, providing the interface to the sauna via standard controls and custom programs
- Sauna power control board and power cable, serving as the power supply relay between the electrical panel (AC power source), heater panels, and the control panel

Below are electrical components detail.

*It is recommended to review the following sections in the National Electrical Code (NEC), chapters 1, 2, 3, 4, & Part IX (Electric Radiant Heating Panels and Heating Panel Sets) before installation.

*Please secure any permits required for your locale before installation.

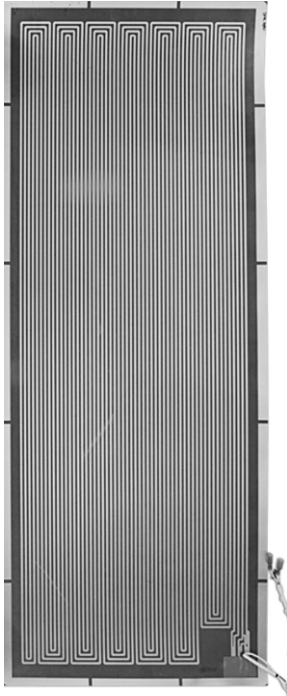

Heater Size (B, D, F)	Standard Wattage	Wattage + 10% (W)	Wattage - 5% (W)	Standard Resistance (Ω)	Resistance Range (+)	Resistance Range (-)
B-120V	300.00	330.0	285.0	48.0	50.5	43.6
B-240V	300.00	330.0	285.0	192.0	202.1	174.5
D-120V	140.0	154.0	133.0	102.8	108.2	93.5
D-240V	140.0	154.0	133.0	411.4	433.0	374.0
F-120V	158.0	173.8	150.1	91.1	95.9	82.8
F-240V	158.0	173.8	150.1	364.5	383.7	331.4

SoloCarbon Heater Panel (Far Infrared)

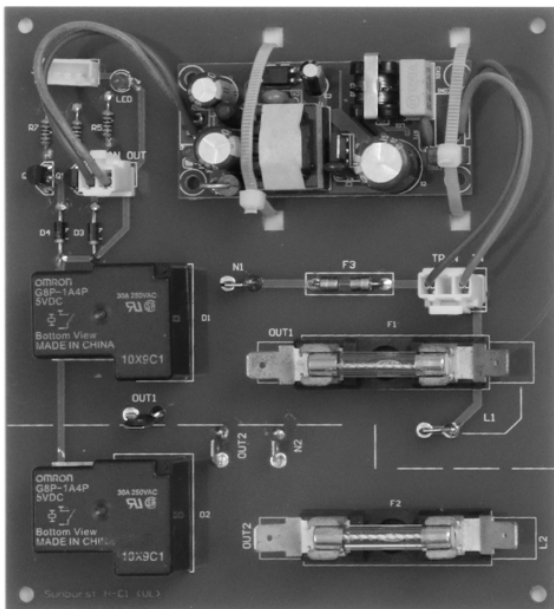

Voltage (V)	Wattage (W)	Amperage (A)	Wattage - 5% (W)
240V	2400 W Per Leg	20 A - 30 A	4800 W - 7200 W

Sauna Control Panel

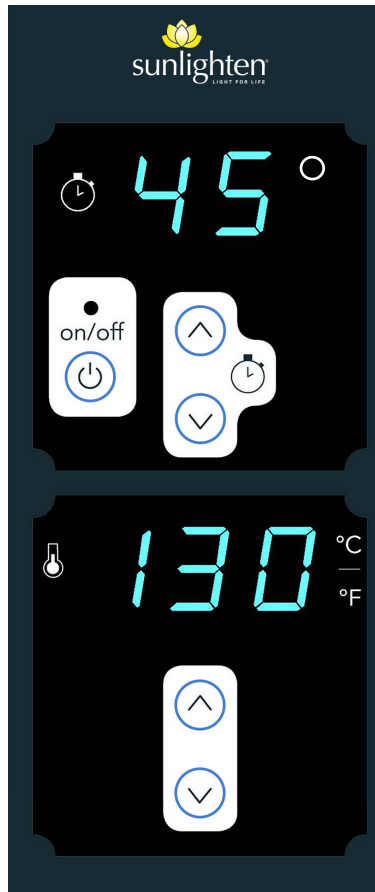

Voltage (V)	Wattage (W)	Amperage (A)
120 V	1350 W	15 A

Sauna Control Cable



AWG	Voltage (VAC)	Amperage (A)	Temperature (°C)	Cable Flame Rating	NEMA Connector
12	120/240V	20 A	125° C	VW-1	5-20 or 6-20

LUMBER AND HARDWARE

All lumber included in the container is premium eucalyptus hardwood or basswood imported from Southeast Asia and shipped nationally from our warehouse in Lenexa, KS.

Timbers included are premium eucalyptus or basswood heater cabinetry (grill and box), premium eucalyptus or basswood tongue-and-groove sauna siding, premium eucalyptus or basswood bench slatting and wooden supports, and premium eucalyptus or basswood trim.

All tongue-and-groove siding is dimensioned in 4 and 6-foot lengths to be cut to length for custom sauna paneling with accompanying eucalyptus or basswood wood trim for concealing kerf lines, wood seams, and end-grain(s).

Bench slats are dimensioned in 2, 3, 4, 5 and 6-foot lengths to be cut to length for custom sauna benching.

*Not included for construction: fasteners, furring strips, and heater cabinetry blocking framing.

Product	Part Number (#)
Eucalyptus or basswood tongue-and-groove siding	TNG10
Eucalyptus or basswood bench slats	BASS/EUCA05
Eucalyptus or basswood heater cabinetry	H1B,D
Eucalyptus or basswood trim	TB08201850
Eucalyptus or basswood bench support boards	BS410



EUCALYPTUS OR BASSWOOD T&G SIDING

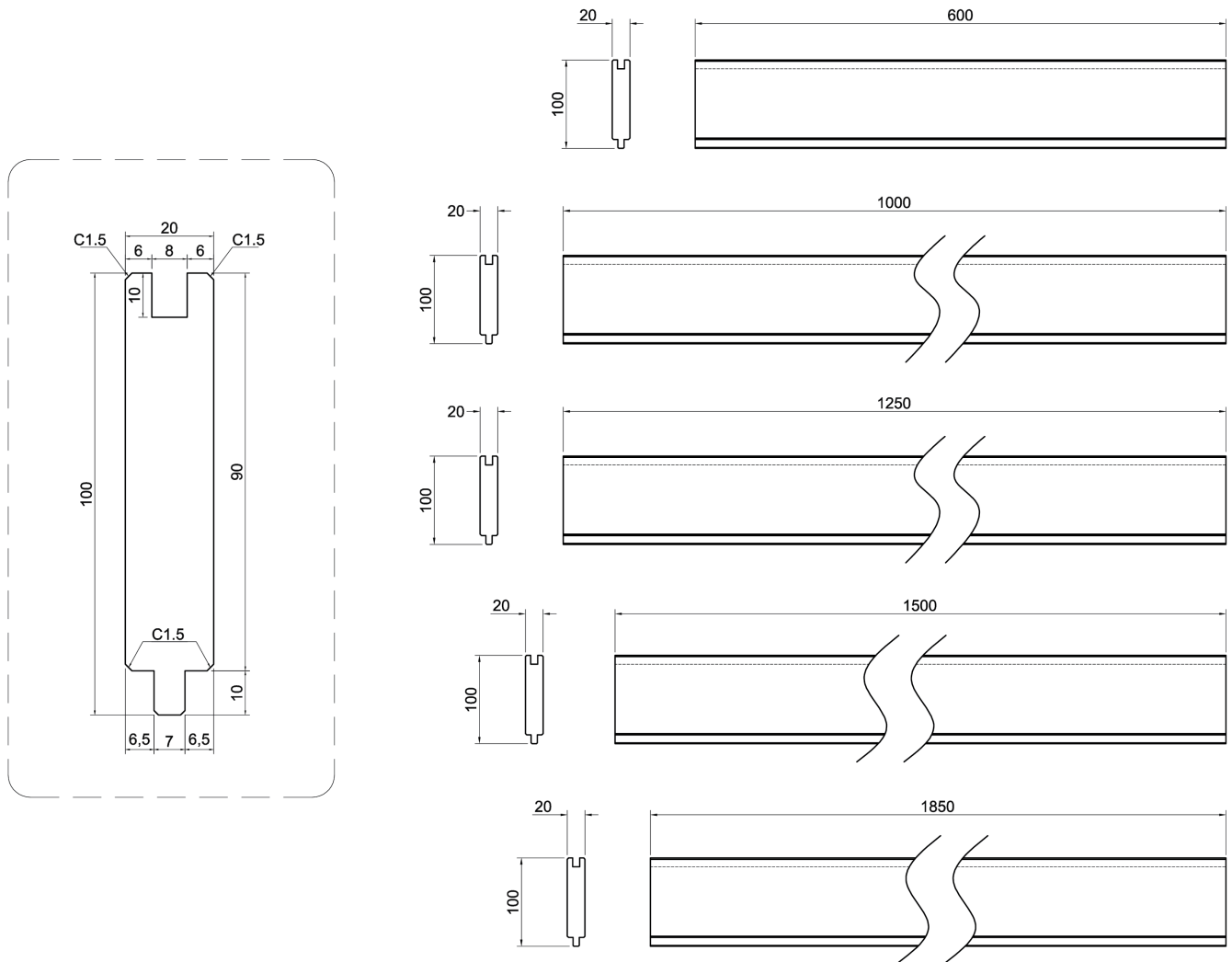

THK (mm/in)	W (mm/in)	L (mm/ft)	Description	Part Number (#)
20 mm (~.787 in)	100 mm (~3.93 in)	600 mm (~1.9 ft)	Eucalyptus or Basswood	TNG1060_EUCA/BASS
20 mm (~.787 in)	100 mm (~3.93 in)	1000 mm (~3.2 ft)	Eucalyptus or Basswood	TNG10100_EUCA/BASS
20 mm (~.787 in)	100 mm (~3.93 in)	1250 mm (~4.1 ft)	Eucalyptus or Basswood	TNG10125_EUCA/BASS
20 mm (~.787 in)	100 mm (~3.93 in)	1500 mm (~4.9 ft)	Eucalyptus or Basswood	TNG10150_EUCA/BASS
20 mm (~.787 in)	100 mm (~3.93 in)	1850 mm (~6.0 ft)	Eucalyptus or Basswood	TNG10185_EUCA/BASS

SAUNA WALL PANELING CUTLIST

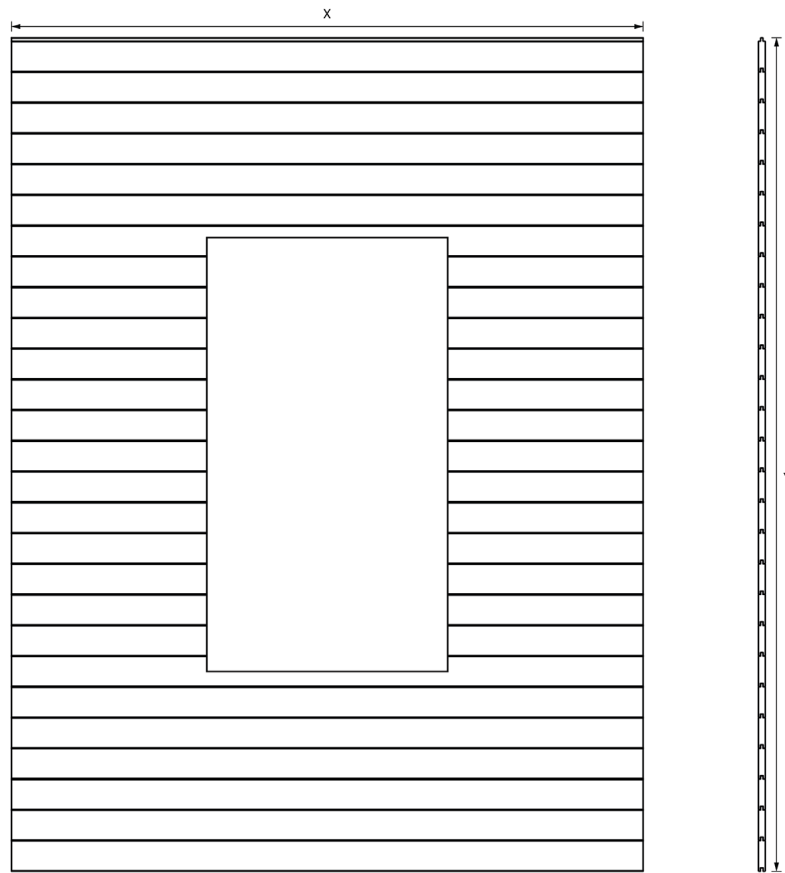

W (mm/in)	L (mm/in)	H (mm/in)	Description	Part Number (#)
Custom	Custom	Custom	Eucalyptus or Basswood	TNG10

EUCALYPTUS OR BASSWOOD TRIM BOARD

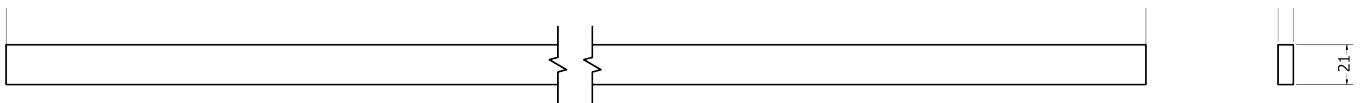

THK (mm/in)	W (mm/in)	L (mm/ft)	Description	Part Number (#)
8 mm (~.314 in)	21 mm (~.826 in)	1829 mm (~6.0 ft)	Eucalyptus or Basswood	TB08201850

EUCALYPTUS OR BASSWOOD HEATER CABINETRY

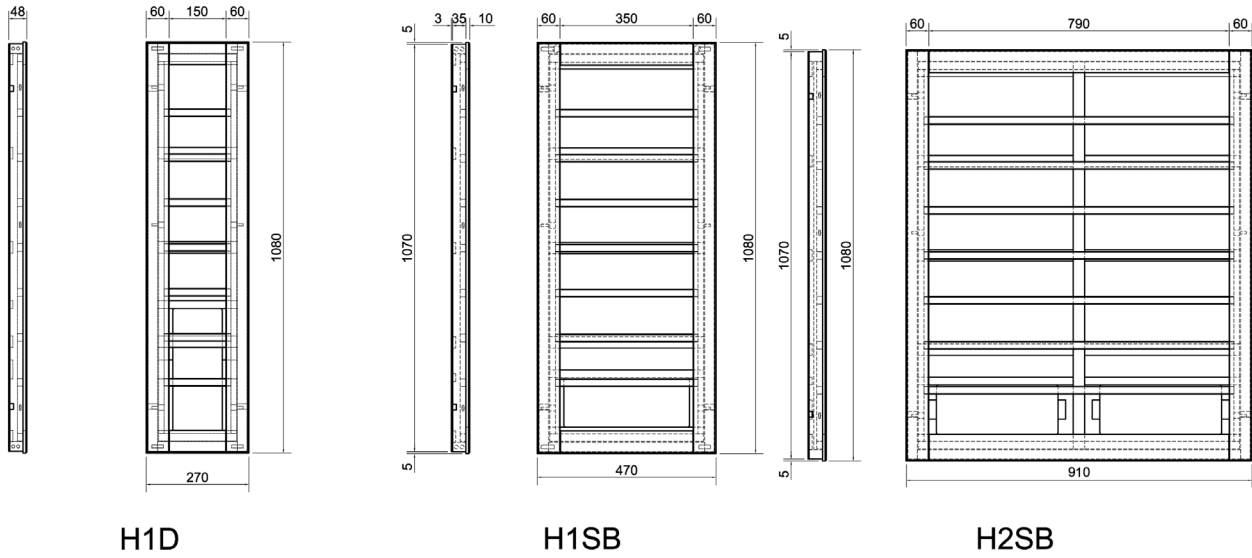

D (mm/in)	W (mm/in)	H (mm/ft)	Description	Part Number (#)
48 mm (~.157 in)	270 mm (~10.6 in)	1080 mm (~3.54 ft)	Eucalyptus or Basswood	H1D
48 mm (~.157 in)	470 mm (~18.5 in)	1080 mm (~3.54 ft)	Eucalyptus or Basswood	H1B
48 mm (~.157 in)	910 mm (~35.2 in)	1080 mm (~3.54 ft)	Eucalyptus or Basswood	H2B

HEATER INSTALLATION DETAIL

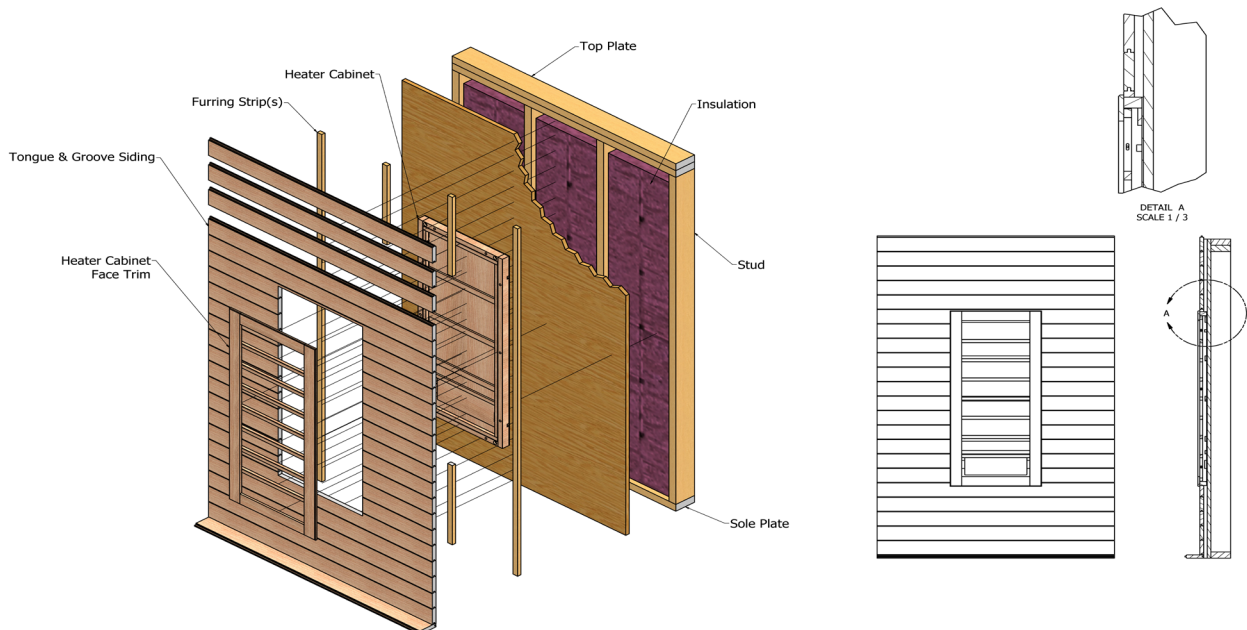

EUCALYPTUS OR BASSWOOD BENCH SLATS



EUCA05125

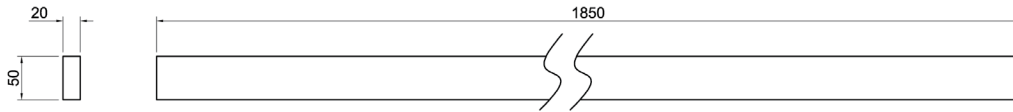

EUCA 05185

THK (mm/in)	W (mm/in)	L (mm/ft)	Description	Part Number (#)
20 mm (~.787 in)	50 mm (~1.96 in)	1250 mm (~4.10 ft)	Eucalyptus or Basswood	BASS/ EUCA05125
20 mm (~.787 in)	50 mm (~1.96 in)	1850 mm (~6.06 ft)	Eucalyptus or Basswood	BASS/ EUCA05185

CUTLIST FOR BENCH SUPPORT BOARDS

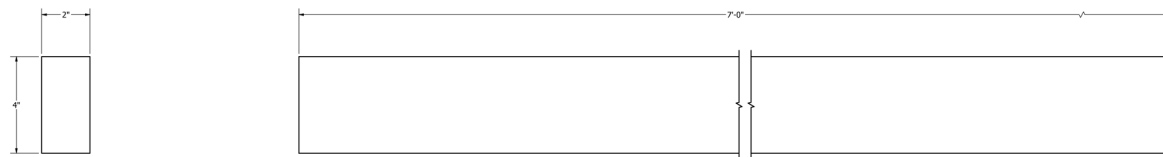
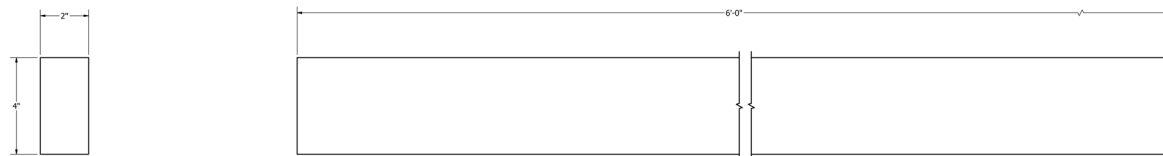

Quantity	T	W	L	Description	Part Number (#)
1	2'	4'	3'	Eucalyptus or Basswood	BS41095-E
1	2'	4'	6'	Eucalyptus or Basswood	BS410185-E
1	2'	4'	7'	Eucalyptus or Basswood	BS410215-E

INSTALLATION

Installing your Sunlighten custom infrared sauna requires knowledge in carpentry, indoor electrical wiring, HVAC, and industrial electronics. Sunlighten recommends hiring certified professional contractors skilled in carpentry and indoor electrical wiring, as well as acquiring all necessary building permits before starting the installation of your custom infrared sauna(s). All commercial sauna installations will need all necessary sprinklers added during installation as recommended by their respective municipalities, fire protection agencies, and building codes. Sunlighten recommends meeting all code compliances applicable for your municipality.

All electrical work is to be done by a certified professional electrician. Sunlighten does not issue electrical design drawings for specific sauna builds. Sunlighten only issues electrical wiring and electronic record documentation on its specific electrical components and products to aid your electrician in designing an appropriate electrical circuit for your specific sauna design and your specific building area.

The following information is provided so your electrician can understand what is needed to wire sauna heaters and heater controls in your particular custom sauna(s). Sunlighten will not recommend a particular design for your custom sauna project or electrical outlet.

Warning: To reduce the risk associated with hazardous voltage and fire, turn off the sauna from the electrical power supply when not in use for extended periods. Keep all liquids away from the heating panels and electronics. Keep flammable objects and corrosive chemical substances away from the sauna. Do not operate sauna if it is not on a dedicated electrical circuit or has a damaged power main or wiring. If the sauna is not working properly or an odor persists, immediately turn off the sauna. Do not leave the sauna unattended while turned on or in use. Never cover heater panels with towels, mats, garments, etc. Install sauna in an area that is dry and protected from the weather. Installation of the sauna in an area below standard room temperature can increase warm up time.

General construction design plans for your specific sauna are provided upon deposit and require customer approval for general overall design intent before an order is placed for procurement of sauna materials. General design plans for your sauna contain all relevant floor plan view(s), ceiling plan view(s), and elevated view(s) needed for customer approval. Other design services may be provided upon request. Additional construction supplements, such as detailed cut lists and assembly instructions will be provided upon request for sauna-specific tongue-and-groove paneling, sauna benching, bench support cabinet hanging, and ceiling light installation. Electrical wiring drawings will not be provided for specific sauna designs.

ELECTRONIC INSTALLATION REFERENCE

The electrical wiring for the heater cabinetry is not provided and must be specified by your electrician to accommodate your custom sauna design. The following information is provided so your electrician is equipped with the necessary information to wire the heaters and heater controls in your custom sauna. Sunlighten will not recommend a particular design or configuration for your sauna project or electrical outlet.

SAUNA CONTROL PANEL LAMINATE

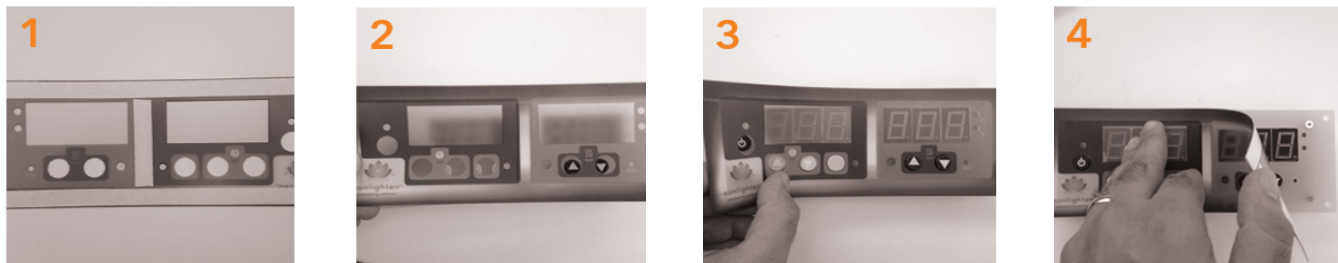

1. Peel tape from laminate
2. Align on front face of Sunlighten sauna control panel
3. Press firmly against laminate to adhere to Sunlighten sauna control
4. Flip Sunlighten sauna control panel upside down to reveal connectors

POWER CONTROL CABLE INSTALL (1)

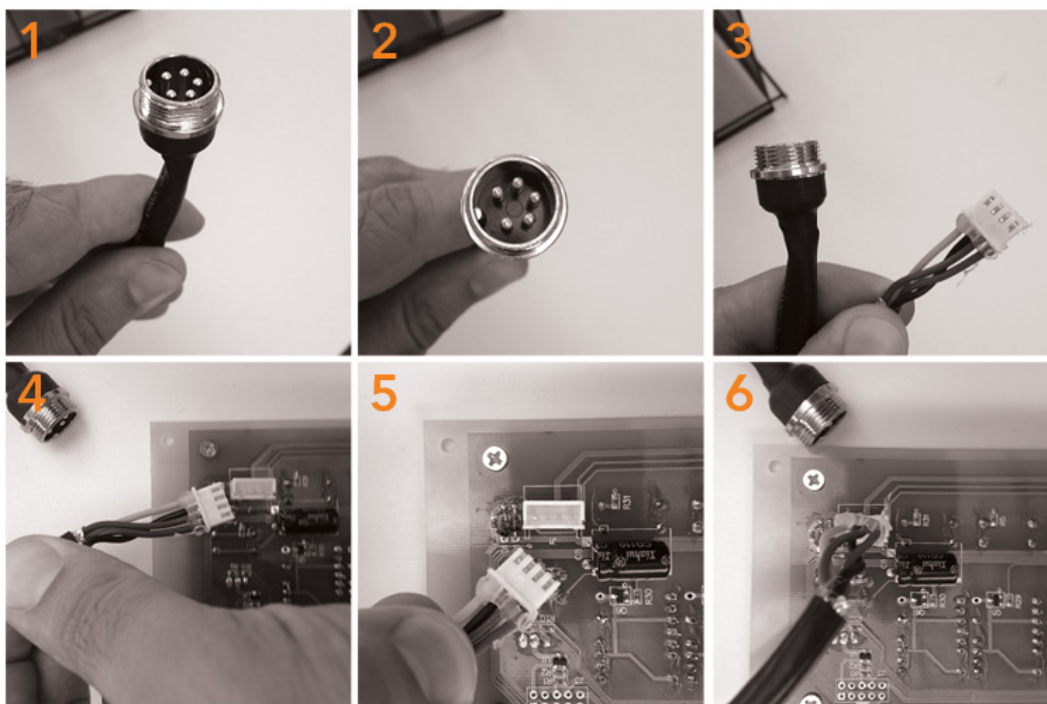

1. Take NEMA 5-20 or 6-20 positive connector
2. Take 4-pin Molex connector and attach it to 4-pin J1 connector on the Sunlighten sauna control panel
3. Make sure connectors are securely seated

POWER CONTROL CABLE INSTALL (2)

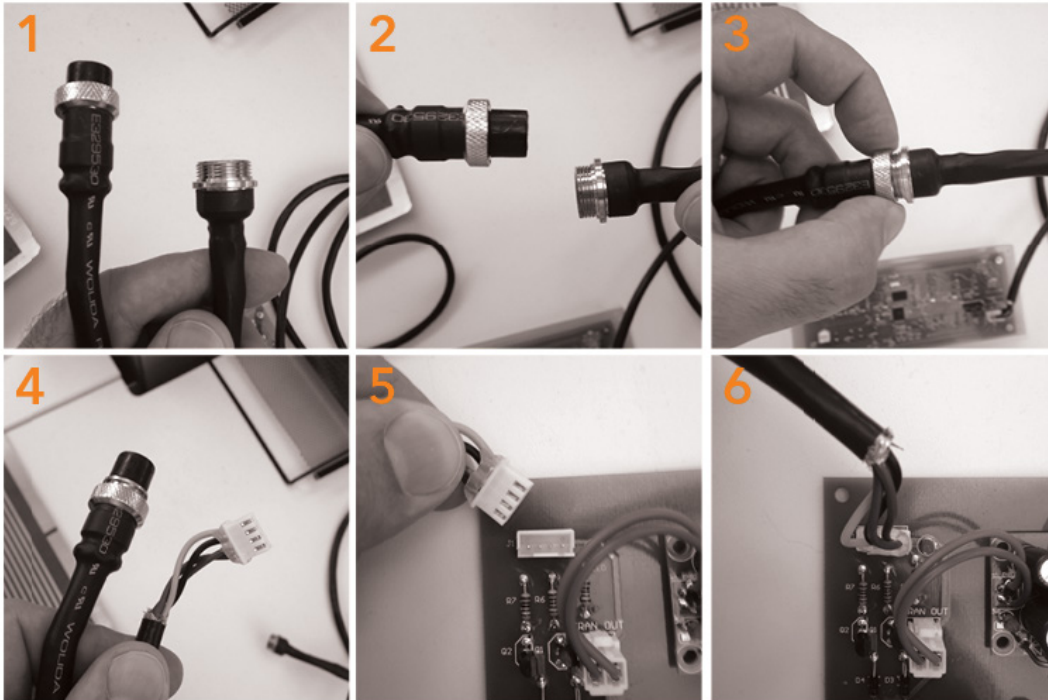

1. Take NEMA 5-20 or 6-20 negative connector
2. Insert NEMA 5-20 or 6-20 positive connector into NEMA 5-20 or 6-20 negative connector
3. Tighten connection via locking nut NEMA 5-20 or 6-20 negative connector
4. Take 4-pin molex connector on NEMA 5-20 or 6-20 negative connector
5. Insert 4-pin molex connector into 4-pin J1 connector on the Sunlighten sauna power control board
6. Make sure connectors are securely seated

HEATER PANEL INSTALL

The Far Infrared heater assemblies can be mounted directly to the plywood wall using the predrilled mounting holes of the heater box assembly's interior frame. The electrical connections are made using the 12" whips extending from the right side of the heater box. These connections can be made on the outside of the box and pushed inside the box once fully connected, similar to a light fixture. If you are using a metal or plastic conduit to run the electrical around the sauna room, you can bring the conduit up to the back of the heater box and enter the assembly through the knock-outs. Depending on your installation or local code requirements, a junction box can be mounted to the knock-out plate and fixed to the plate with self-taping screws.

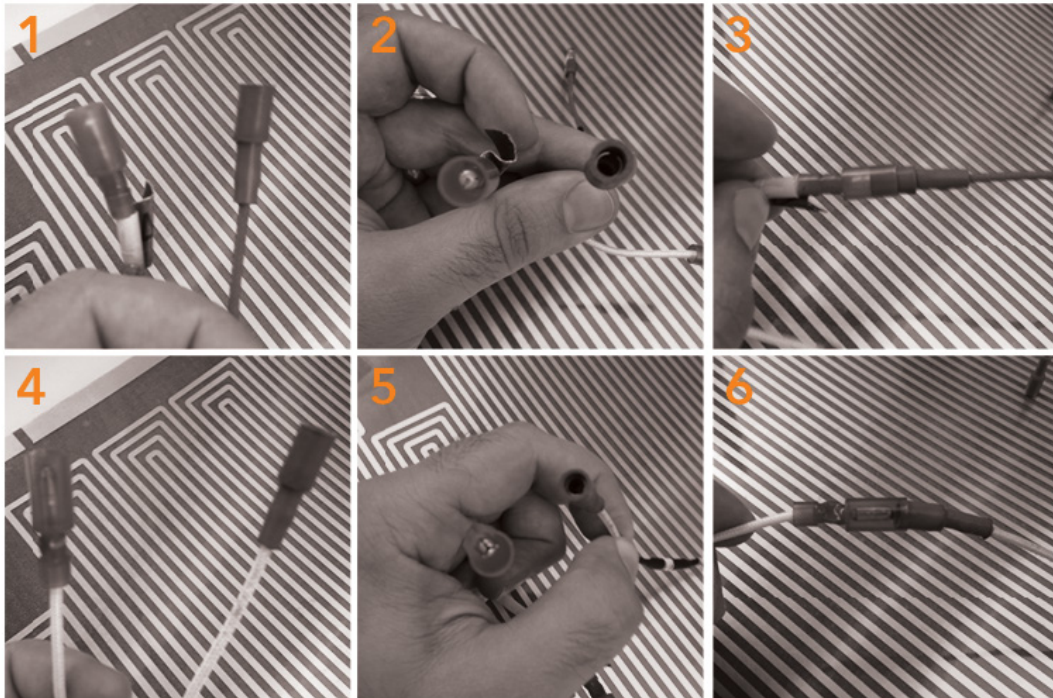
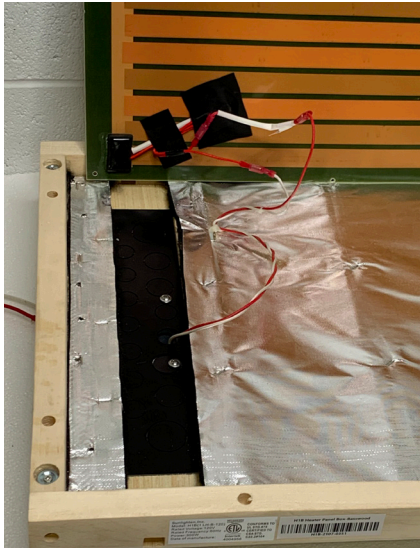
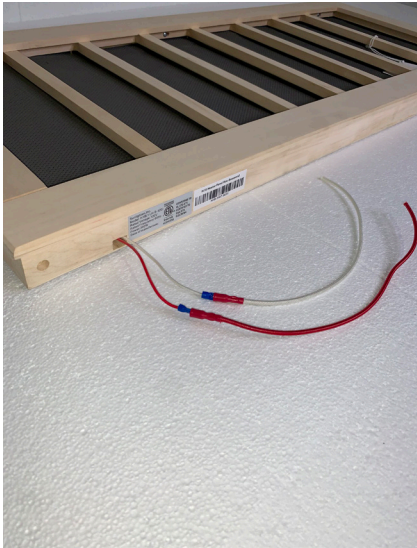

1. Take NEMA 5-20 or 6-20 negative connector
2. Insert NEMA 5-20 or 6-20 positive connector into NEMA 5-20 or 6-20 negative connector
3. Tighten connection via locking nut NEMA 5-20 or 6-20 negative connector
4. Take 4-pin molex connector on NEMA 5-20 or 6-20 negative connector
5. Insert 4-pin molex connector into 4-pin J1 connector on the Sunlighten sauna power control board
6. Make sure connectors are securely seated

WIRING POWER CONTROL BOARD

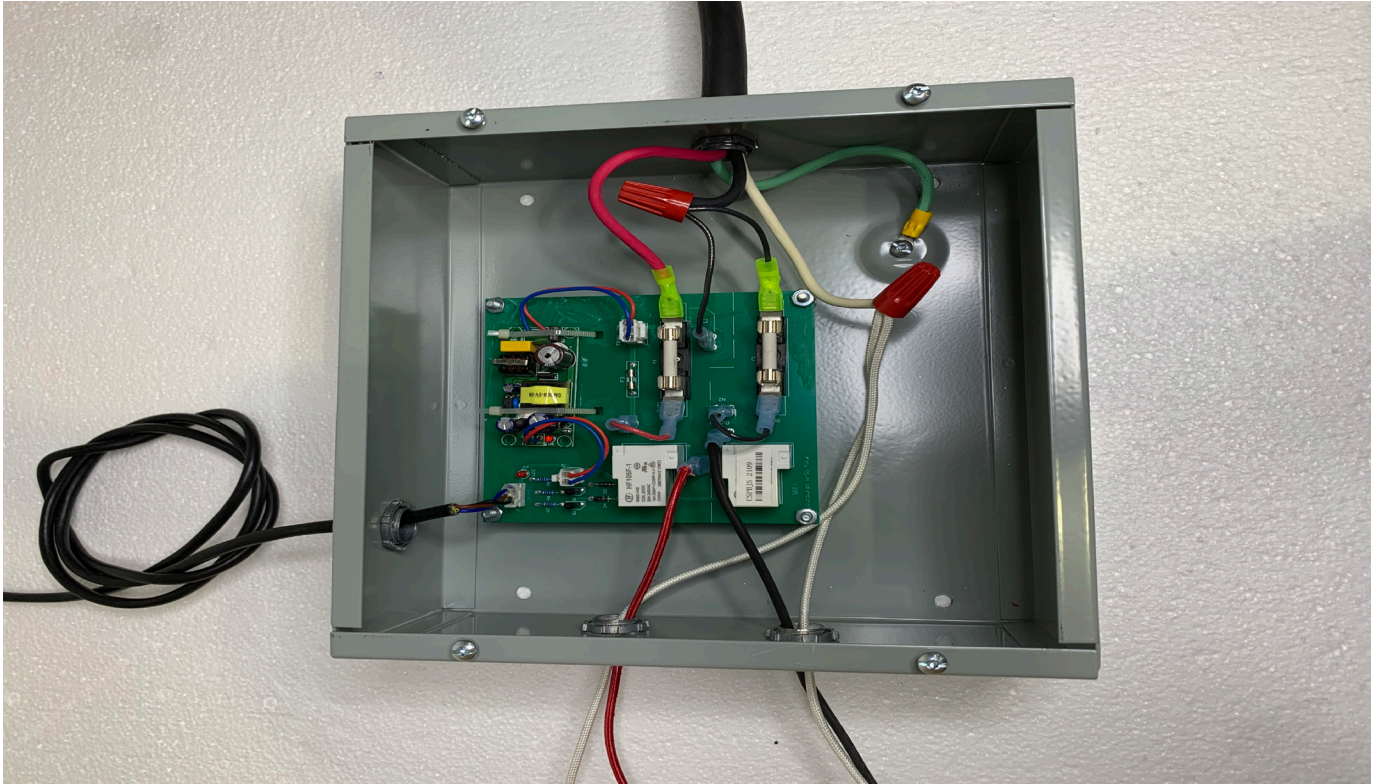

1. N1 Quick Connect Terminal Non-insulated
2. N2 Quick Connect Terminal Non-insulated
3. OUT1 Quick Connect Terminal Non-insulated and OUT2 Quick Connect Terminal Non-Insulated
4. L1 Quick Connect Terminal Non-insulated
5. F1 Conquer Fuse (AC, 250V, 20A)
6. F2 Conquer Fuse (AC, 250V, 20A)

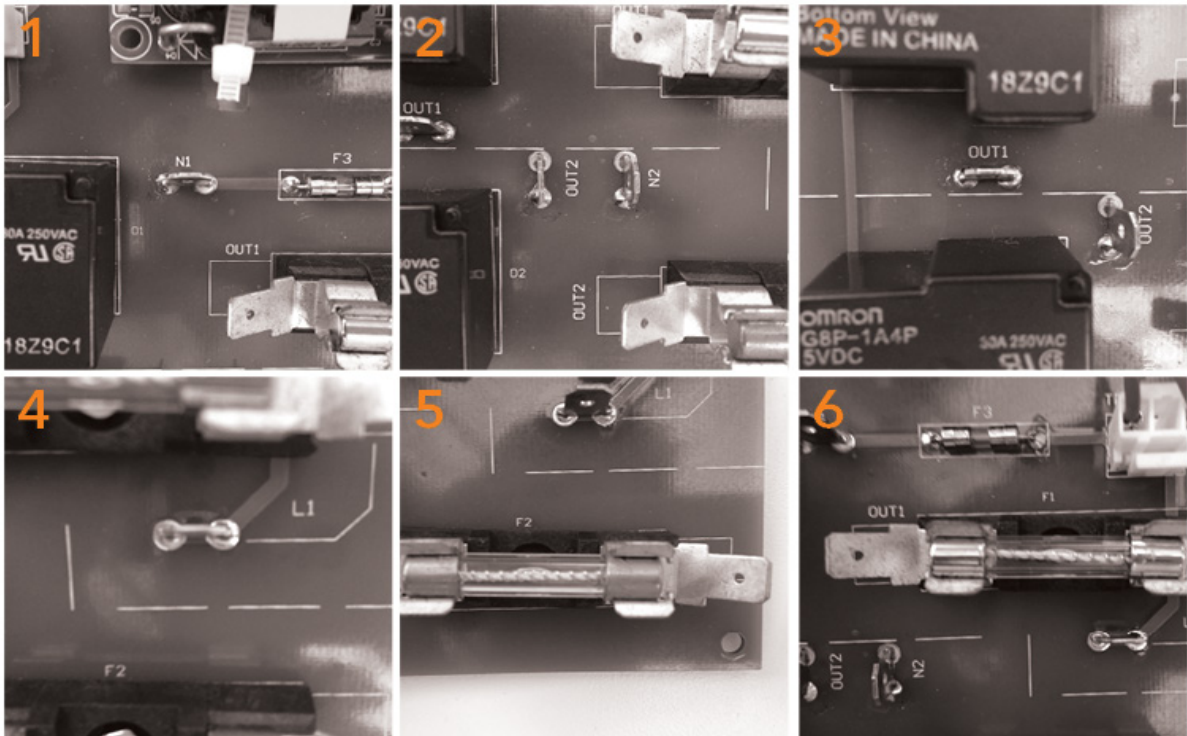

FULL SPECTRUM HEATERS



The full spectrum heaters are designed to be mounted in a corner and pointed outward at a 45-degree angle. The mounting hardware can be repositioned and mounted on a flat surface pointing straight outwards. The power lead into the heater can be connected to the sauna's 120v supply using the whip coming out of the bottom of the assembly. A hardwired connection using spade or bullet style connectors is the most common, however the whip can be connected to a plug (NEMA 5-15) and plugged into a wall mounted receptacle. This receptacle can be mounted to the wall behind the heater assembly and hidden from plain sight.



WIRING L1 TO POWER CONTROL BOARD

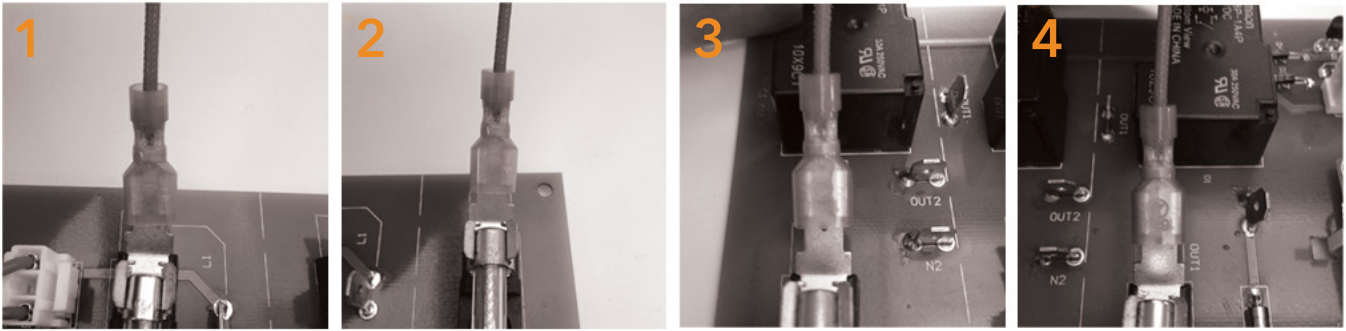

1. Take L1 wire quick connect connector and attach it onto F1 quick connect terminal on Sunlighten power control board
2. Take L1 wire quick connect connector and attach it onto N1 quick connect terminal on Sunlighten power control board
3. Take OUT1 wire quick connect connector and attach it onto heater panel bullet connector

WIRING L2 TO POWER CONTROL BOARD

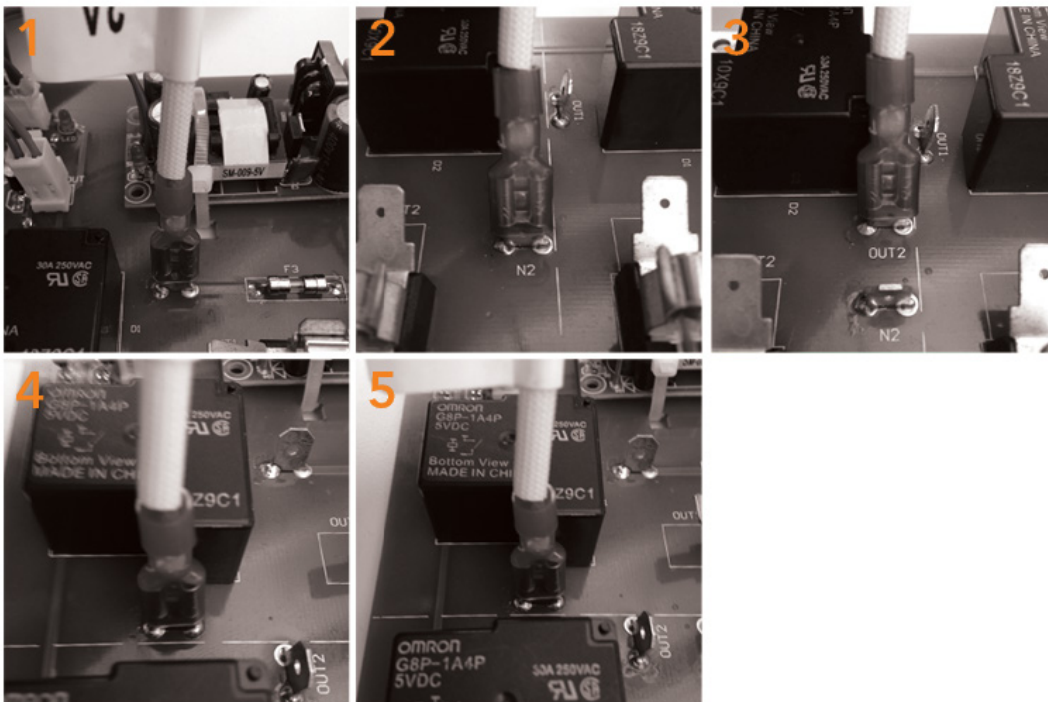

1. Take L2 wire quick connect connector and attach it onto L1 quick connect terminal on Sunlighten power control board
2. Take L2 wire quick connect connector and attach it onto F2 quick connect terminal on Sunlighten power control board
3. Take L2 wire quick connect connector from OUT2 and attach it onto N2 quick connect terminal on Sunlighten power control board
4. Take L2 wire quick connect connector from OUT2 and attach it onto heater panel bullet connector

CIRCUIT WIRING

The Controller is composed of a Power Board and Control Panel, designed for 3 wire, 25A 240V operation for reduced amperage. The heaters, rated at 120V, must only be used in series parallel. Wiring and enclosures are not provided.

The labeling on the board is as follows: The two 120V inputs on the board are labeled L1+N1 and L2+N2, with each input connected to your 120V phases Line1 and Line2 (Conventional electrical nomenclature identifies L1 and L2 as line one and line two of one 240V input). A separate neutral line needs to be supplied to the heaters outside of the PC board. This line will connect directly to the neutral busbar.

Also, L1 on the board has two lugs, one on the PC board and one on the fuse. The lug on the PC board feeds the DC electronic power supply. You will need to make an additional Y connection off the L2 side of the 120V input to accommodate the two lugs. Lug or "blade" size is 6 mm. You will need quick connectors of this size to terminate your wires for the inputs and outputs.

To summarize:

INPUT 1

- **F1 = Line 1 (ungrounded conductor phase 1, black wire)**
- **OUT1 on Fuse to N1 on PC Board**
- **Output 1 on PC Board - first leg of heater panels (heaters connected in series parallel)**

INPUT 2

- **F2 = Line 1 (ungrounded conductor phase 1, black wire) - Y-connection to L1 on PC Board**
- **OUT2 on Fuse - to N2 on PC Board**
- **Output 2 on PC Board - Second leg heater panels (heaters connected in series parallel)**

The ground is only used on an electrical enclosure you would provide for the H-C1 circuit board. An 8"x 8" or larger wiring enclosure for the Power Board is recommended. The heater load should be divided between OUT1 and OUT2. Each of the two relays on the circuit board can handle a maximum of 8 heaters total. You can wire a total of 8 heaters to OUT1 and 8 heaters to OUT2. This gives a maximum of 8 parallel connected heaters or 16 heaters per Power Board. The two leads on each heater are terminated with female "bullet" connectors which are 5 mm ID. The red leads will connect to the 120V power supply, and the white leads will connect to the neutral line. You can terminate your wiring with the matching 5mm OD bullet connectors or remove the bullet connector and use your wiring connector.

A 4-pin Control Cable is provided to connect the Power Board with the low voltage Control Panel. It is six feet long to provide flexibility in positioning the Control Panel relative to the Power Board. The Control Panel is the keypad/display module and is made to be surface-mounted. The Control Panel biases the temperature reading from the board-mounted temperature probe.

*Note: Your electrician should run a 4-wire, 10 guage 25A, 240 V line to the supplied circuit board. This type of wire includes 2 - hot legs, 1 - neutral leg, and a ground wire.

Wire SoloCarbon heater panels in series parallel to the circuit board (120 V to each heater).

Each sauna circuit can support up to 5760 watts. Any amount of power over this number will require a second circuit to be supplied. Both circuits can be controlled through one controller when using our Booster board. This board will take the signal from each circuit board and boost the signal up to 5v to the control panel. A maximum of 2 circuits can be run through this booster board.

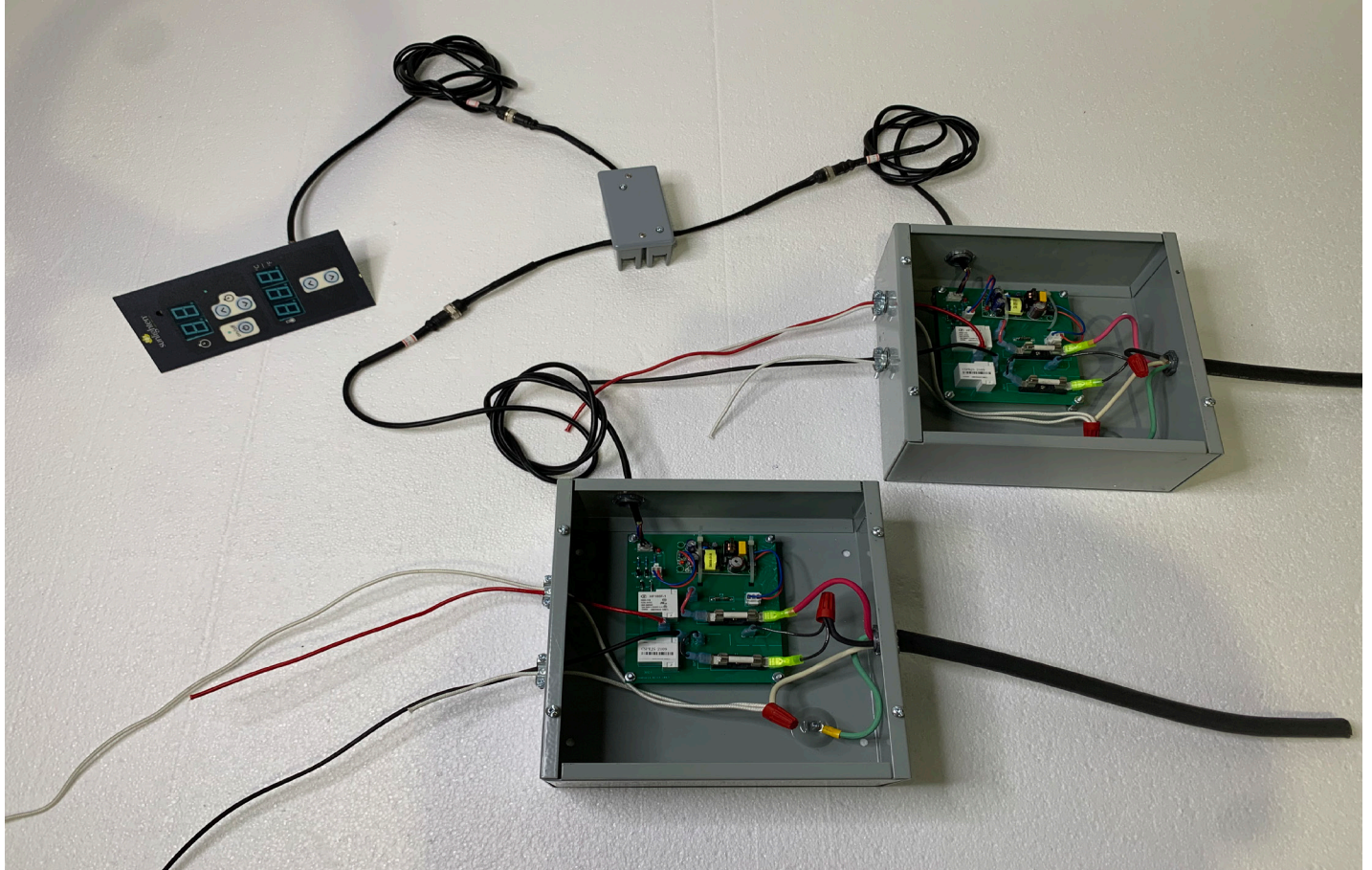
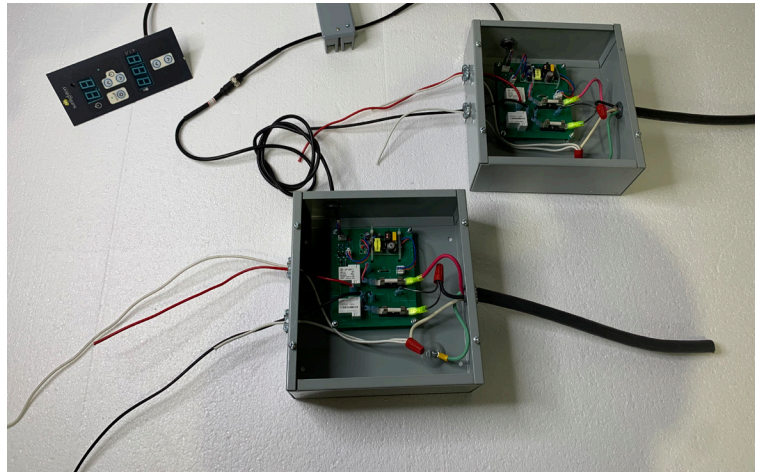

HOW TO INSTALL TONGUE-AND-GROOVE SIDING

Tongue-and-groove siding refers to a type of siding that has under and overlapping edges that interlock to form a durable, weather-resistant surface. Below is a simple, comprehensive guide to installing tongue-and-groove siding from beginning to end.

Tongue-and-Groove Siding Installation Instructions:

1. Prep wall surface
2. Determine your style of installation
3. Install the first piece
4. Finish first row
5. Install corners
6. Second-row installation
7. Subsequent rows
8. Cutting around obstacles
9. Install last row of siding
10. Apply trim

1. PREP WALL SURFACE

Connections are to be made between the sauna control panel, temperature probe (if included), and the power control board via the power control cable. If included, the custom control panel will have the temperature probe built into the panel unless the panel is being mounted on the sauna's exterior, in which case an additional temperature probe will be required. Subsequent connections are to be made to the power control board, heater panels (in series-parallel), and electrical panel (AC power source).

2. DETERMINE YOUR STYLE OF INSTALLATION

A benefit of tongue-and-groove siding is the variety of options available. It can be applied horizontally, vertically or diagonally. The most common orientation is horizontal, working from the top down, and will be the used for the following instructions.

3. INSTALL THE FIRST PIECE

To install the first piece of siding, line it up with the bottom of the wall against an edge, such as a doorframe. The tongue section of the board should be at the top, with the groove section at the bottom. If the siding is up to 6 inches wide, it can be nailed with one siding nail per bearing; but siding any wider should use two nails per bearing. Nails should penetrate 1-1/4 inch into solid wood behind the siding.

Now that you have begun to install the siding, you will need to install the first and subsequent rows, as well as maneuver around obstacle areas such as a window(s) and door(s).

4. FINISH FIRST ROW

Once the first piece of siding is installed, you can finish this first row. Simply put the next piece of siding flush up to the first piece, and nail in the same manner. Continue in this fashion until you reach a corner.

5. CORNERS

For inside corners, the siding is typically positioned against either a trim strip or an adjoining wall.

6. SECOND-ROW INSTALLATION

To begin installation of the second row of siding, start again above the first piece of wood you have installed. The piece of siding installed above the initial piece should be a different length, so the edges are not uniform throughout. This piece should be hammered down so the tongue-and-groove interlock to create a strong siding, and then nailed in like the initial row. Continue this method for the rest of the row.

7. SUBSEQUENT ROWS

Repeat this process for all subsequent rows to completion. You can choose to use the same length of wood for the first piece of siding and every other row, or you can choose to be more random in your length selections, depending on your desired look. Be sure to use a different length than the previous row when starting a new one to make the siding more secure and weatherproof.

8. CUTTING AROUND OBSTACLES

When approaching a window or door opening, the precision of your measurements is important. Before finalizing placement and nailing pieces down, you should measure how much siding is needed to adjoin the siding and the opening and/or trim. Cuts should be made carefully and verified before installing. Each board must be measured and trimmed separately, so it's best not to cut several boards to a specific length without measuring for each row. When you have reached the last row of your tongue-and-groove siding installation, it is time to apply trim.

9. INSTALL LAST ROW OF SIDING

Install the last row of siding as you did the others. If necessary, cut the top portion down to size horizontally. The tongue portion will not be needed to interlock with any pieces above it, so cut it straight across and allow it to sit contiguously against the top of the wall.

10. APPLY TRIM

After finishing the entire wall of siding, it is time to apply trim boards as desired. Common places are the outer edges of window and door frames, and additional options are ceilings and floors. Trim can be nailed in, similarly to the siding, and any visible nail holes can be covered with putty if desired.

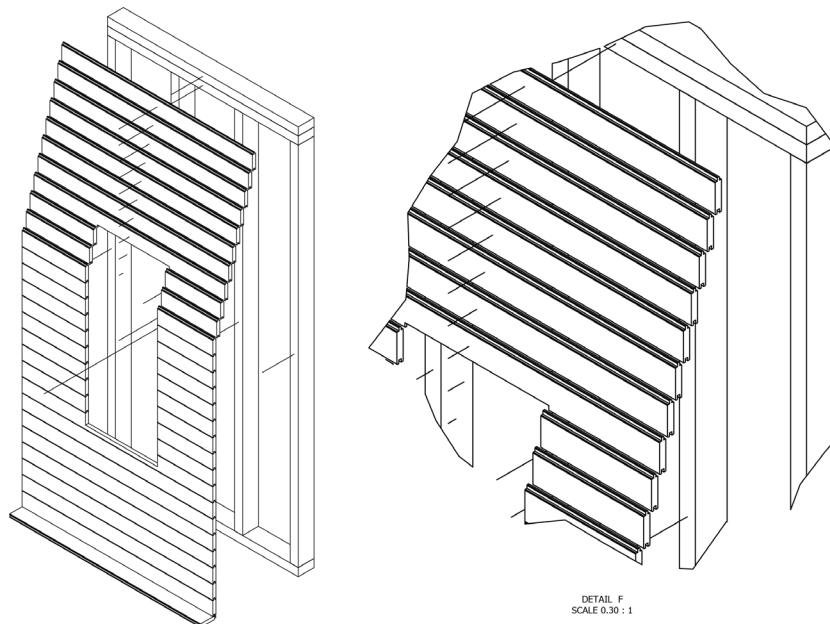

120 V 20 A CIRCUIT WIRING DIAGRAM

(Single Power Control Board Installation)

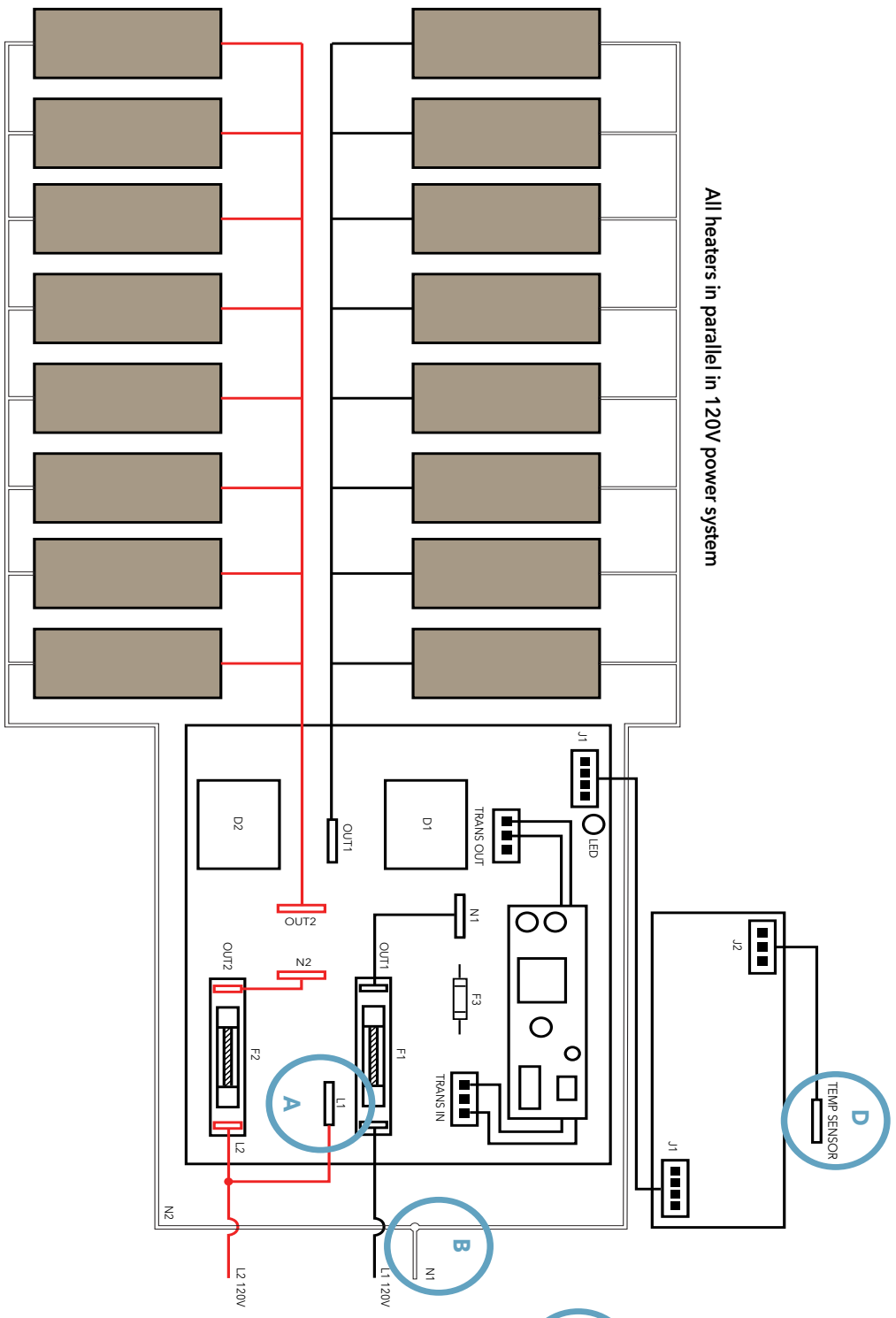

All heaters in parallel in 120V power system

- Circle A** - Incoming L2 needs to be spliced onto this L1 pin. If incoming L1 line is connected here, the control panel will not power on.
- Circle B** - All Neutral lines will be connected together and tied back to the breaker panel.
- Circle C** - The incoming Ground wire can be screwed down to the ground post inside the metal junction box.
- Circle D** - The temp sensor is only included if your control panel is mounted externally. An internal control panel has a temp sensor built into the panel.

SAUNA OPERATION

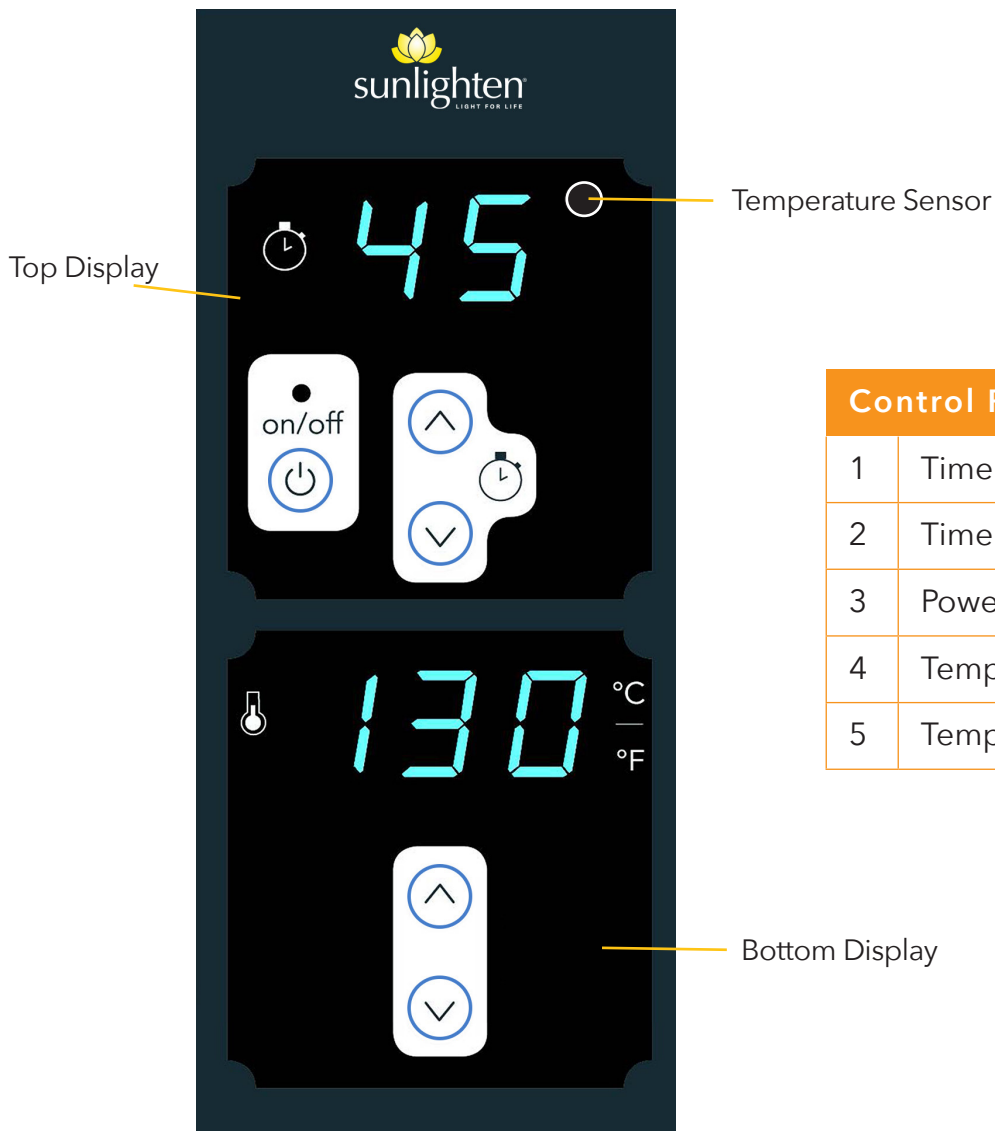

Control Functions	
1	Time Display
2	Time Control
3	Power
4	Temperature Display
5	Temperature Control

CONTROL PANEL

1. Plug in sauna
2. Press the On/Off button to activate your sauna
3. Top Display: Press arrow Up or Down to set desired session time (sauna heaters will automatically turn off when time has reached or been set to 0)
4. Bottom Display: Press arrow Up or Down to set desired temperature

Note: Press both temperature arrows simultaneously to change from Celsius to Fahrenheit. After 5 seconds the display will show actual interior temperature.

TROUBLESHOOTING GUIDE

ISSUE	SOLUTION
An electrical component is not working after assembling	Check all connections - a newly assembled unit with a non-functioning electrical component (control panel, heater panels, lights, speakers) will most likely have a missed or loose connection.
Sauna has no power	There could be a tripped breaker due to a power surge or not being plugged into a dedicated outlet. Flip the breaker switch (a round, black reset button located to the left of the power box on the roof). If there is still no power, check the power cord connections on the roof and make sure they are secure. Also verify the outlet power.
Slow warm-up time	Ensure each wall panel is heating and that you have the correct electrical specifications on a dedicated circuit.
E1 Error Message on Control Panel	The E1 error code indicates a broken temperature sensor on the board. Please contact Customer Care for troubleshooting assistance and a replacement.

*For other troubleshooting questions, please contact customer care at 877-292-0020 ext. 4.

HEALTH & SAFETY

Our infrared saunas operate with the same efficacy in your home as in a medical facility. Like all professional equipment, you may put yourself at risk if you do not fully understand how to use the sauna. Infrared sauna use as creating a cure for or treating any disease is neither implied nor should be inferred. Drinking an electrolyte-replacing water or a sports drink is strongly recommended before and after use.

IMPORTANT SAFEGUARDS

- Never sleep inside the sauna while it is on.
- Do not use harsh cleaning agents on the interior of the sauna.
- Do not stack or store objects on top of or inside the sauna.
- Do not use during an electrical storm, as there is a remote risk of shock.
- Altering or tampering with any electrical connections on the power supply is dangerous and will void the warranty.
- Do not attempt a repair without consulting Sunlighten first. Unauthorized repair attempts will void the warranty.

PRECAUTIONS

If any of the below apply to you, consult your physician prior to sauna use:

- Medications
- Children
- Elderly
- Chronic conditions / diseases associated with reduced ability to sweat or perspire
- Hemophiliacs / individuals who are prone to bleeding
- Cardiovascular conditions
- Pacemaker / defibrillator
- Alcohol / alcohol abuse
- Fever
- Sensitivity to heat
- Pregnancy
- Joint Injury
- Implants

For more information on saunas and contraindications, visit sunlighten.com/contraindications.

WARRANTY

Warranty covers normal use for the product and is defined as three (3) years for heaters and one (1) year for electronics. Warranty is limited to replacement parts only and does not include costs for shipping warranty parts after 90 day(s) receipt of goods. Any cost of labor and/or service technicians is not included.

This warranty extends only to the original retail or wholesale purchaser of the sauna and terminated upon transfer of ownership. The sauna must be installed and used within one year of the manufactured date. Freight charges to and from the customer are the responsibility of the customer. This includes freight charges for parts shipped to enable the services of the sauna.

This warranty is void if the sauna has been altered, misused, abused, or exposed to water. Such instances shall include operation or maintenance of the sauna in deviation to the published instructions. The warranty extends only to the manufacturing defects and does not cover the damages resulting from mishandling of the product by the owner.

Sunlighten Corp. shall not be liable for the loss of use of the sauna or other incidental or consequential damages. Under no circumstances shall Sunlighten Corp. or any of its representatives be held liable for injury to any persons or damages to any properties. Specifications are subject to change without notice.

ATTENTION: Shipping damage must be notated on the Bill of Lading (BOL). Sunlighten must be notified of any damage to your sauna within two (2) business days of signing the BOL. Failure to notify Sunlighten within the established time frame will result in the owner taking full responsibility for cost of all replacement parts, including shipping and handling fees.

Return Policy

Buyer may cancel and return the Goods to Seller, subject to the terms and conditions of this document, if Buyer provides written notice to Seller within thirty (30) days of Buyer's receipt of the Goods that Buyer does not accept the Goods.

In the event the Buyer elects to cancel the order and return the Goods pursuant to this Paragraph, Buyer shall assume all risk of loss and transportation and handling charges in connection therewith. Seller reserves the right to refuse to refund any deposit or payment or cancel any payment due and owing until such time as Seller (a) is in receipt of the Goods; (b) has inspected the Goods; and, (c) in Seller's discretion, has found such Goods to be free of damage. ALL RETURNED GOODS MUST BE IN THEIR ORIGINAL PACKAGING. In addition to other legal and equitable remedies available to Seller, Seller may refuse to refund all or any portion of any deposit or payment or cancel any payment due and owing if the Buyer fails to fully comply with or violates the terms and conditions of this document.

WARRANTY CONTINUED

Generated computer aided drafting (CAD) design of sauna(s) and related design/visualization services, drawing(s), file(s) and virtual asset(s) costs are non-refundable. \$1,000 will be withheld from any refund to account for costs incurred throughout the design phase of custom sauna.

Shipping & Handling Fee

All cancelled or returned Goods shall be subject to shipping costs (to and from) and handling fees in the event Buyer cancels Buyer's order after shipment has commenced.



CUSTOM INFRARED SAUNA
INSTALLATION MANUAL
VERSION 08082022

US / CAN 7373 W. 107th St. | Overland Park, KS 66212
913.754.0831 | sunlighten.com

International sunlighten.com
or contact your local Sunlighten representative